

# Reassessment of the Atomic Bomb Radiation Dosimetry for Hiroshima and Nagasaki

– Dosimetry System 2002 –

***NOTE: free-field radiation  
doses are attenuated in  
concrete buildings & shelters***

Report of the Joint US–Japan Working Group

Editors:

Robert W. Young  
George D. Kerr

放影研  
RERF

2005

RADIATION EFFECTS RESEARCH FOUNDATION  
A Cooperative Japan–United States Research Organization

**Table 1. Comparison of integral quantities: DS02**

Quantity	Units	DS02
<b>Hiroshima</b>		
Total neutrons	moles/kt	0.1768
Average neutron energy	MeV	0.3106
Total gamma rays	moles/kt	0.006665
Average gamma ray energy	MeV	1.3979
Yield range	kt	15-18
<b>Nagasaki</b>		
Total neutrons	moles/kt	0.2640
Average neutron energy	MeV	0.0126
Total gamma rays	moles/kt	0.09022
Average gamma ray energy	MeV	1.2667
Yield range	kt	18-22

The uncertainty for the Hiroshima yield is, in part, attributable to not knowing exactly when neutron multiplication began. In this device it was possible to have the configuration reach a supercritical geometry while the assembly was still in progress. Moreover, once the parts reached their final configurations, it was still necessary for a free neutron to be present from which multiplication by fission could proceed in the supercritical geometry. The designers of the device were well aware of the time interval in which the configuration was supercritical and in need of the initial neutron to begin multiplication. In fact, they made estimates of the full device yield as a function of the time at which neutron multiplication began. In an attempt to produce maximum yield, a component referred to as an “initiator” was designed and tested to introduce an initial number of neutrons into the supercritical configuration near the “optimal” time. In an effort to insure that neutron multiplication would begin as nearly as possible to the optimal time in the supercritical configuration, four polonium-beryllium initiators were used instead of just one. While the neutron production rate remains classified, the source strength of the initiators was remeasured on August 5, 1945 and found to be well within design specification.

Source: Radiation Effects Research Foundation,  
“Reassessment of the Atomic Bomb Radiation Dosimetry  
for Hiroshima and Nagasaki”, DS02, 2002, vol. 1, page 64.

# Hiroshima Neutron Leakage Spectrum

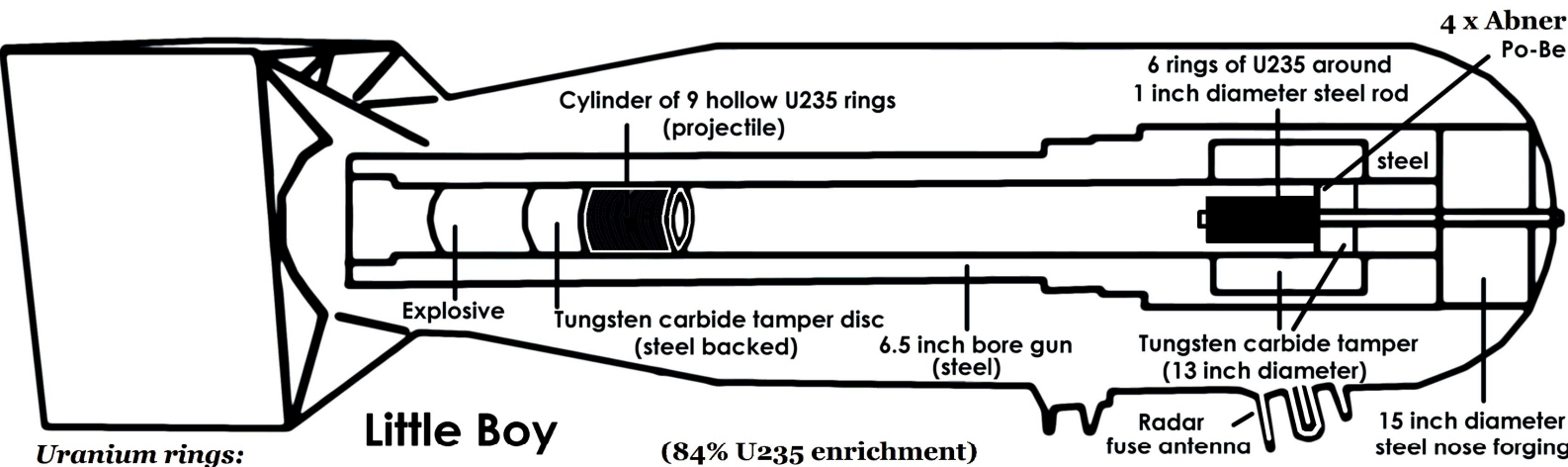
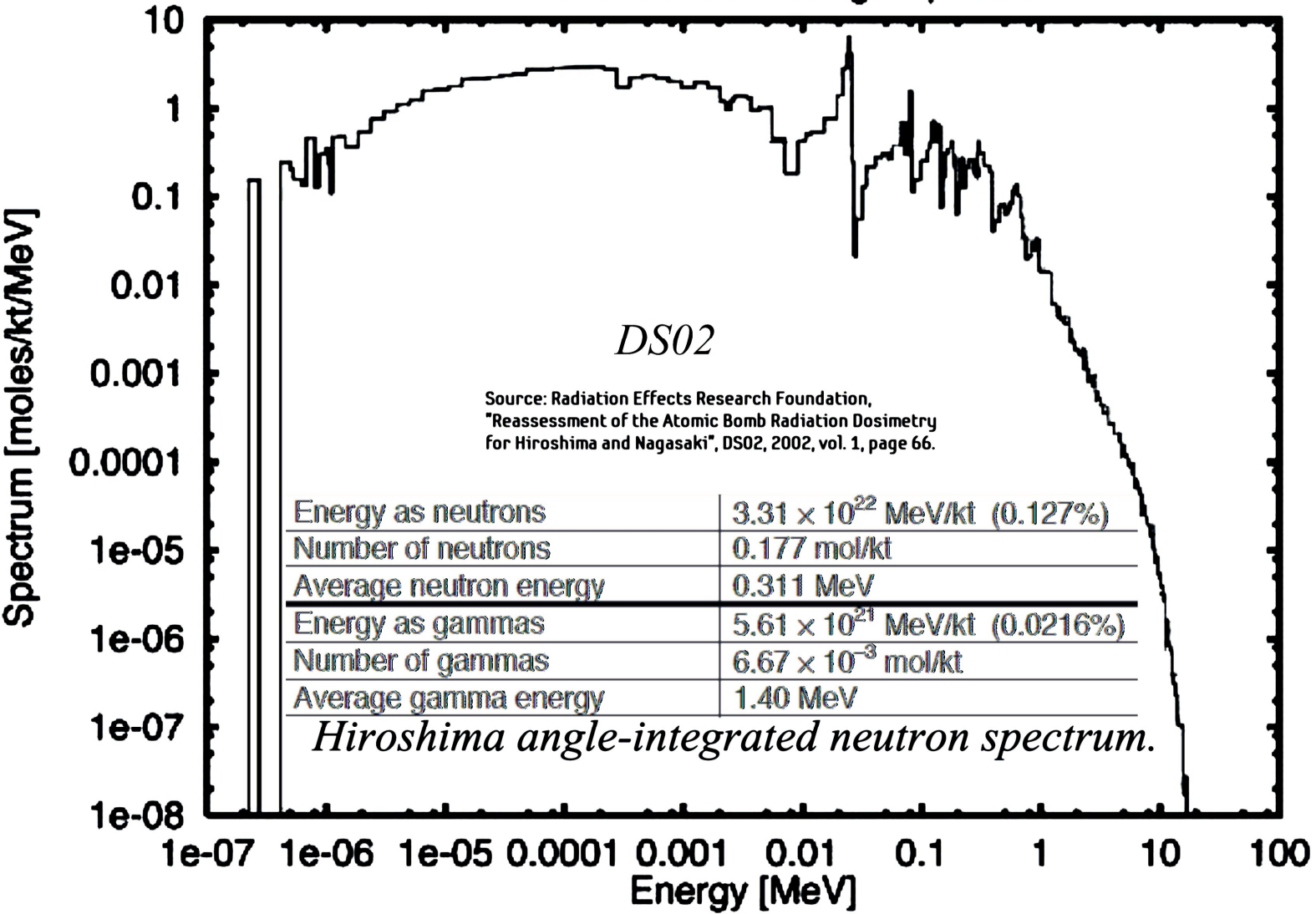

Uranium rings:

51.55 kg U was  
80.4% U235  
enriched

50 kg U was 89%  
U235 enriched

14.1 kg U was 50%  
U235 enriched

**Little Boy**

(84% U235 enrichment)

Illustration 6.25" diameter, 16.25" long projectile, including 7" length of 9 hollow (4" bore) uranium rings (38.5 kg), followed by a tungsten carbide tamper/neutron reflector disc, steel-backed to the chemical explosive charge. It was pushed 42" along the 72" long gun barrel into 6 hollow 4" diameter uranium discs 7" long (25.6 kg), with a 1" bore hole filled by a steel axis bolt extending through the 2,300 kg tungsten carbide/steel nose assembly.

# Hiroshima Delayed Gamma at 1,500 meters

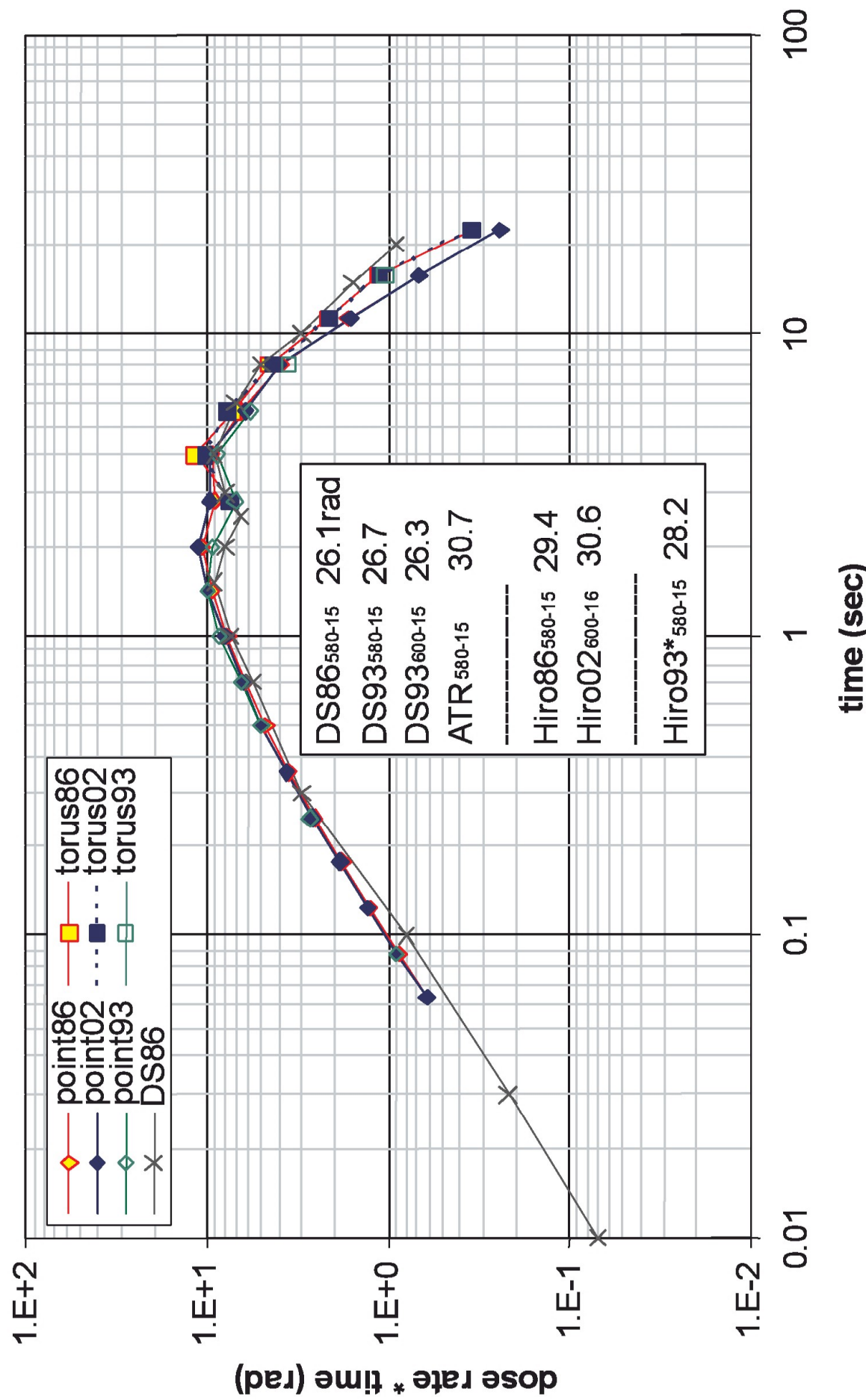

Figure 35. Time-dependent delayed gamma-ray radiation at 1,500 m ground range for Hiroshima; integrated dose (rads) given for several calculation assumptions.

# Hiroshima HOB = 600 m; Y = 16 kt

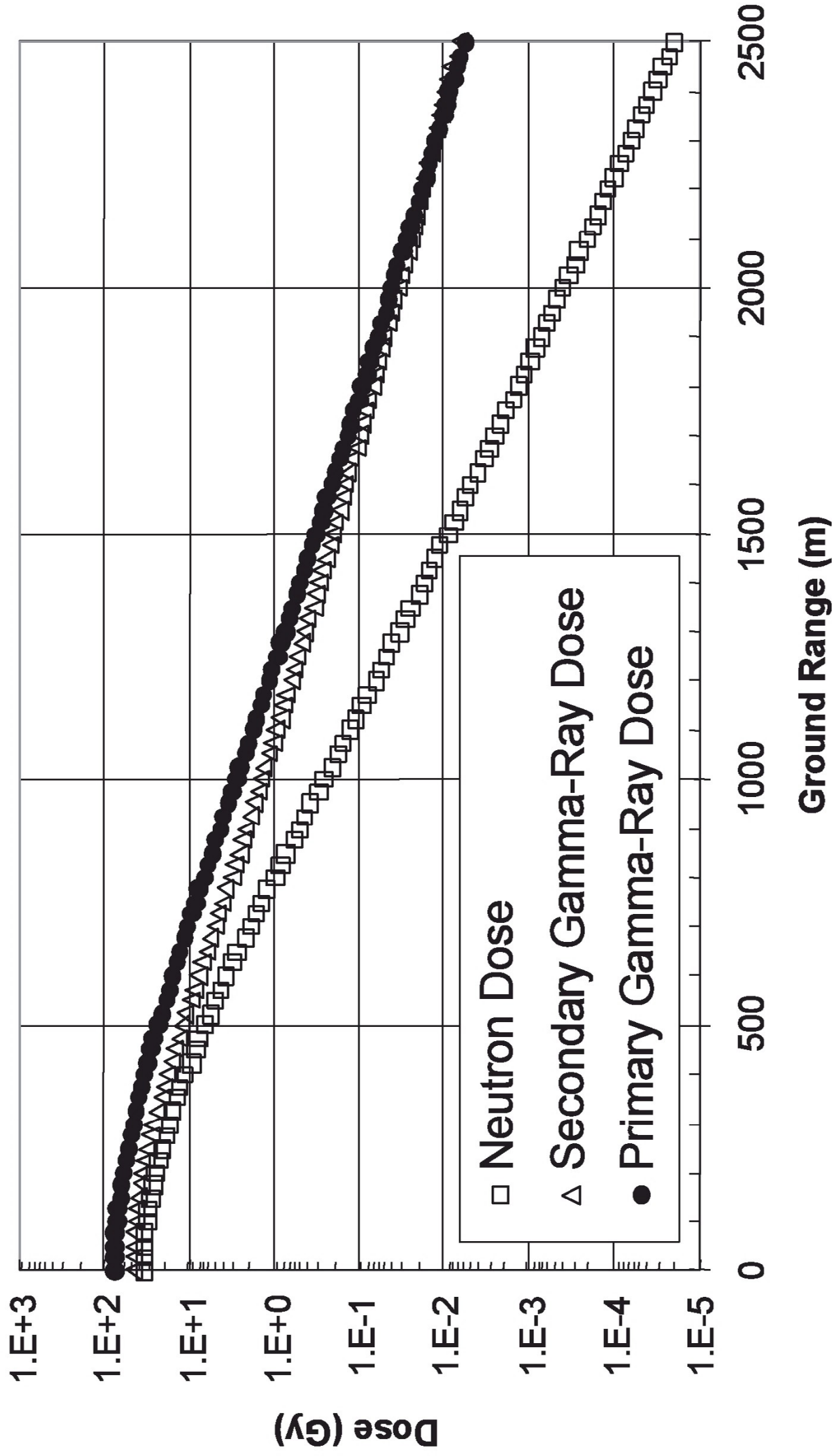

Figure 39. Hiroshima dose vs. ground range, HOB = 600 m, yield = 16 kt.

# Nagasaki HOB = 503 m; Y = 21 kt

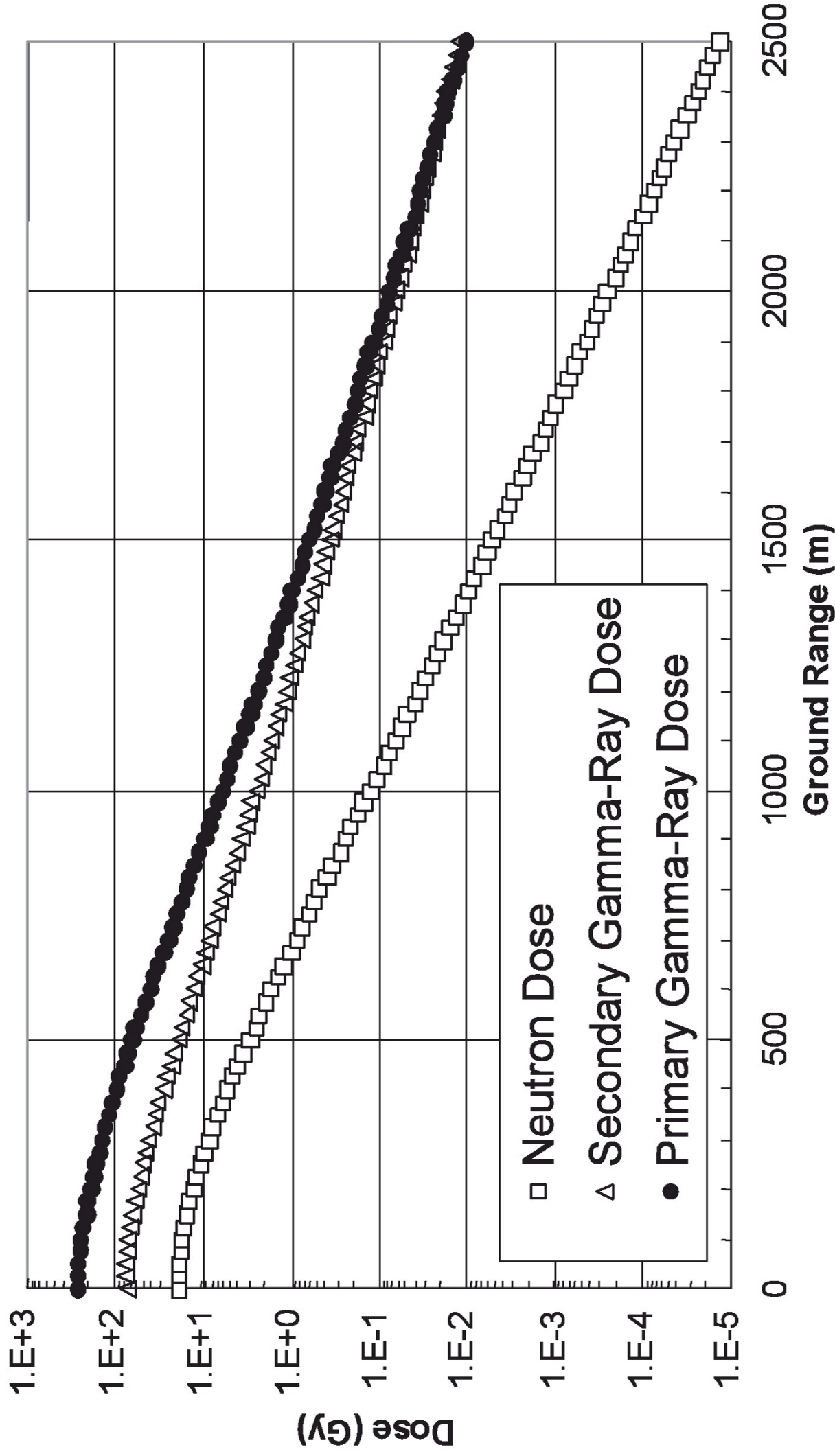

Figure 46. Nagasaki dose vs. ground range, HOB = 503 m, yield = 21 kt.

Table 11. DS02 Hiroshima doses for 600-m HOB above standard ground at 16-kt yield

Ground range meter	Slant range meter	Neutron dose				Secondary gamma dose				Primary gamma dose				Total gamma dose			
		Prompt	Delayed	Total	gray	Prompt	Delayed	Total	gray	Prompt	Delayed	Total	gray	Prompt	Delayed	Total	gray
		gray	gray	gray	gray	gray	gray	gray	gray	gray	gray	gray	gray	gray	gray	gray	gray
0	599	3.16E+1	2.96E+0	3.45E+1	4.45E+1	1.51E+0	4.61E+1	6.18E-1	7.38E+1	7.44E+1	4.52E+1	7.53E+1	1.20E+2				
100	607	2.93E+1	2.73E+0	3.20E+1	4.18E+1	1.42E+0	4.32E+1	7.22E-1	7.10E+1	7.17E+1	4.25E+1	7.24E+1	1.15E+2				
200	632	2.29E+1	2.16E+0	2.51E+1	3.42E+1	1.18E+0	3.53E+1	6.86E-1	5.96E+1	6.02E+1	3.48E+1	6.07E+1	9.56E+1				
300	670	1.60E+1	1.48E+0	1.75E+1	2.54E+1	8.84E-1	2.63E+1	5.90E-1	4.61E+1	4.67E+1	2.60E+1	4.70E+1	7.30E+1				
400	720	1.02E+1	9.19E-1	1.11E+1	1.76E+1	6.13E-1	1.82E+1	5.02E-1	3.39E+1	3.44E+1	1.81E+1	3.46E+1	5.27E+1				
500	780	5.98E+0	5.09E-1	6.48E+0	1.17E+1	4.00E-1	1.21E+1	3.91E-1	2.32E+1	2.36E+1	1.21E+1	2.36E+1	3.57E+1				
600	848	3.33E+0	2.76E-1	3.61E+0	7.55E+0	2.53E-1	7.81E+0	2.90E-1	1.55E+1	1.58E+1	7.84E+0	1.58E+1	2.36E+1				
700	921	1.80E+0	1.49E-1	1.95E+0	4.92E+0	1.60E-1	5.08E+0	2.07E-1	1.02E+1	1.04E+1	5.12E+0	1.04E+1	1.55E+1				
800	999	9.24E-1	7.20E-2	9.96E-1	3.18E+0	9.95E-2	3.28E+0	1.50E-1	6.58E+0	6.73E+0	3.33E+0	6.68E+0	1.00E+1				
900	1081	4.80E-1	3.62E-2	5.17E-1	2.08E+0	6.29E-2	2.15E+0	9.98E-2	4.22E+0	4.32E+0	2.18E+0	4.28E+0	6.47E+0				
1000	1166	2.42E-1	1.77E-2	2.60E-1	1.38E+0	4.08E-2	1.42E+0	7.09E-2	2.73E+0	2.80E+0	1.45E+0	2.77E+0	4.22E+0				
1100	1253	1.20E-1	8.29E-3	1.29E-1	9.21E-1	2.66E-2	9.48E-1	4.98E-2	1.75E+0	1.80E+0	9.71E-1	1.78E+0	2.75E+0				
1200	1341	6.25E-2	3.99E-3	6.65E-2	6.26E-1	1.77E-2	6.44E-1	3.59E-2	1.13E+0	1.16E+0	6.62E-1	1.15E+0	1.81E+0				
1300	1431	3.18E-2	1.92E-3	3.37E-2	4.27E-1	1.20E-2	4.39E-1	2.57E-2	7.21E-1	7.47E-1	4.53E-1	7.33E-1	1.19E+0				
1400	1523	1.62E-2	9.05E-4	1.71E-2	2.92E-1	8.15E-3	3.01E-1	1.73E-2	4.71E-1	4.88E-1	3.10E-1	4.79E-1	7.89E-1				
1500	1615	8.60E-3	4.41E-4	9.04E-3	2.03E-1	5.65E-3	2.08E-1	1.25E-2	3.06E-1	3.18E-1	2.15E-1	3.12E-1	5.27E-1				
1600	1708	4.51E-3	2.11E-4	4.72E-3	1.40E-1	3.92E-3	1.44E-1	8.72E-3	2.00E-1	2.09E-1	1.49E-1	2.04E-1	3.53E-1				
1700	1802	2.39E-3	1.02E-4	2.49E-3	9.80E-2	2.73E-3	1.01E-1	6.08E-3	1.31E-1	1.37E-1	1.04E-1	1.33E-1	2.37E-1				
1800	1897	1.28E-3	5.06E-5	1.33E-3	6.88E-2	1.92E-3	7.07E-2	4.24E-3	8.99E-2	9.41E-2	7.30E-2	9.18E-2	1.65E-1				
1900	1992	6.86E-4	2.47E-5	7.11E-4	4.85E-2	1.36E-3	4.99E-2	3.02E-3	5.75E-2	6.05E-2	5.16E-2	5.88E-2	1.10E-1				
2000	2088	3.73E-4	1.24E-5	3.86E-4	3.45E-2	9.68E-4	3.54E-2	2.32E-3	3.87E-2	4.10E-2	3.68E-2	3.96E-2	7.64E-2				
2100	2184	2.05E-4	6.28E-6	2.11E-4	2.46E-2	6.93E-4	2.53E-2	1.68E-3	2.54E-2	2.71E-2	2.63E-2	2.61E-2	5.24E-2				
2200	2280	1.13E-4	3.19E-6	1.16E-4	1.76E-2	4.98E-4	1.81E-2	1.20E-3	1.66E-2	1.78E-2	1.88E-2	1.71E-2	3.59E-2				
2300	2377	6.25E-5	1.64E-6	6.41E-5	1.26E-2	3.58E-4	1.30E-2	8.53E-4	1.15E-2	1.24E-2	1.35E-2	1.19E-2	2.53E-2				
2400	2474	3.48E-5	8.46E-7	3.56E-5	9.05E-3	2.59E-4	9.31E-3	6.09E-4	7.94E-3	8.55E-3	9.66E-3	8.20E-3	1.79E-2				
2500	2571	1.94E-5	4.38E-7	1.99E-5	6.53E-3	1.88E-4	6.72E-3	4.37E-4	5.38E-3	5.82E-3	6.97E-3	5.57E-3	1.25E-2				



Table 13. DS02 Nagasaki doses for 503-m HOB above standard ground at 21-kt yield

Ground range meter	Slant range meter	Neutron dose			Secondary gamma dose			Primary gamma dose			Total gamma dose		
		Prompt gray	Delayed gray	Total gray	Prompt gray	Delayed gray	Total gray	Prompt gray	Delayed gray	Total gray	Prompt gray	Delayed gray	Total gray
0	502	1.08E+1	7.97E+0	1.88E+1	7.17E+1	3.35E+0	7.50E+1	6.12E+1	1.92E+1	2.53E+2	1.33E+2	1.96E+2	3.28E+2
100	512	1.00E+1	7.18E+0	1.72E+1	6.88E+1	3.10E+0	7.19E+1	5.93E+1	1.81E+2	2.40E+2	1.28E+2	1.84E+2	3.12E+2
200	540	7.49E+0	5.38E+0	1.29E+1	5.34E+1	2.47E+0	5.58E+1	4.44E+1	1.48E+2	1.92E+2	9.78E+1	1.50E+2	2.48E+2
300	585	5.21E+0	3.45E+0	8.67E+0	3.97E+1	1.75E+0	4.14E+1	3.33E+1	1.10E+2	1.43E+2	7.30E+1	1.12E+2	1.85E+2
400	642	3.29E+0	1.97E+0	5.26E+0	2.80E+1	1.12E+0	2.91E+1	2.27E+1	7.55E+1	9.82E+1	5.06E+1	7.66E+1	1.27E+2
500	709	1.94E+0	1.03E+0	2.97E+0	1.85E+1	6.78E-1	1.92E+1	1.47E+1	4.92E+1	6.39E+1	3.31E+1	4.99E+1	8.30E+1
600	782	1.13E+0	5.22E-1	1.65E+0	1.21E+1	3.99E-1	1.25E+1	9.45E+0	3.12E+1	4.07E+1	2.16E+1	3.16E+1	5.32E+1
700	861	6.06E-1	2.49E-1	8.56E-1	8.21E+0	2.31E-1	8.44E+0	5.80E+0	1.93E+1	2.51E+1	1.40E+1	1.95E+1	3.35E+1
800	944	3.38E-1	1.20E-1	4.58E-1	5.58E+0	1.37E-1	5.72E+0	3.77E+0	1.20E+1	1.58E+1	9.36E+0	1.21E+1	2.15E+1
900	1031	1.81E-1	5.67E-2	2.37E-1	3.67E+0	8.23E-2	3.75E+0	2.30E+0	7.44E+0	9.74E+0	5.97E+0	7.52E+0	1.35E+1
1000	1119	9.82E-2	2.64E-2	1.25E-1	2.48E+0	5.06E-2	2.53E+0	1.52E+0	4.56E+0	6.08E+0	4.00E+0	4.61E+0	8.62E+0
1100	1209	5.20E-2	1.24E-2	6.45E-2	1.62E+0	3.23E-2	1.65E+0	9.35E-1	2.84E+0	3.78E+0	2.56E+0	2.87E+0	5.43E+0
1200	1301	2.83E-2	5.88E-3	3.41E-2	1.10E+0	2.10E-2	1.13E+0	6.07E-1	1.76E+0	2.37E+0	1.71E+0	1.78E+0	3.49E+0
1300	1394	1.53E-2	2.77E-3	1.81E-2	7.61E-1	1.39E-2	7.75E-1	4.03E-1	1.11E+0	1.51E+0	1.16E+0	1.12E+0	2.28E+0
1400	1487	8.26E-3	1.32E-3	9.58E-3	5.19E-1	9.37E-3	5.28E-1	2.61E-1	7.05E-1	9.66E-1	7.80E-1	7.15E-1	1.49E+0
1500	1582	4.47E-3	6.39E-4	5.11E-3	3.60E-1	6.41E-3	3.66E-1	1.71E-1	4.46E-1	6.17E-1	5.30E-1	4.53E-1	9.83E-1
1600	1677	2.44E-3	3.11E-4	2.75E-3	2.54E-1	4.43E-3	2.58E-1	1.14E-1	2.89E-1	4.04E-1	3.68E-1	2.94E-1	6.62E-1
1700	1773	1.34E-3	1.51E-4	1.49E-3	1.80E-1	3.07E-3	1.83E-1	7.75E-2	1.83E-1	2.60E-1	2.57E-1	1.86E-1	4.43E-1
1800	1869	7.38E-4	7.47E-5	8.13E-4	1.27E-1	2.15E-3	1.29E-1	5.21E-2	1.18E-1	1.70E-1	1.79E-1	1.20E-1	2.99E-1
1900	1965	4.05E-4	3.72E-5	4.43E-4	8.86E-2	1.52E-3	9.02E-2	3.50E-2	7.92E-2	1.14E-1	1.24E-1	8.07E-2	2.04E-1
2000	2062	2.25E-4	1.89E-5	2.44E-4	6.21E-2	1.08E-3	6.32E-2	2.37E-2	5.15E-2	7.52E-2	8.58E-2	5.26E-2	1.38E-1
2100	2159	1.25E-4	9.69E-6	1.35E-4	4.39E-2	7.68E-4	4.46E-2	1.62E-2	3.39E-2	5.01E-2	6.01E-2	3.47E-2	9.47E-2
2200	2257	7.05E-5	4.97E-6	7.55E-5	3.15E-2	5.51E-4	3.20E-2	1.13E-2	2.19E-2	3.32E-2	4.28E-2	2.25E-2	6.52E-2
2300	2354	3.98E-5	2.60E-6	4.24E-5	2.29E-2	3.96E-4	2.32E-2	7.96E-3	1.53E-2	2.33E-2	3.08E-2	1.57E-2	4.65E-2
2400	2452	2.24E-5	1.36E-6	2.38E-5	1.66E-2	2.87E-4	1.69E-2	5.60E-3	1.02E-2	1.58E-2	2.22E-2	1.04E-2	3.27E-2
2500	2550	1.28E-5	7.13E-7	1.35E-5	1.21E-2	2.08E-4	1.23E-2	3.93E-3	6.58E-3	1.05E-2	1.60E-2	6.79E-3	2.28E-2

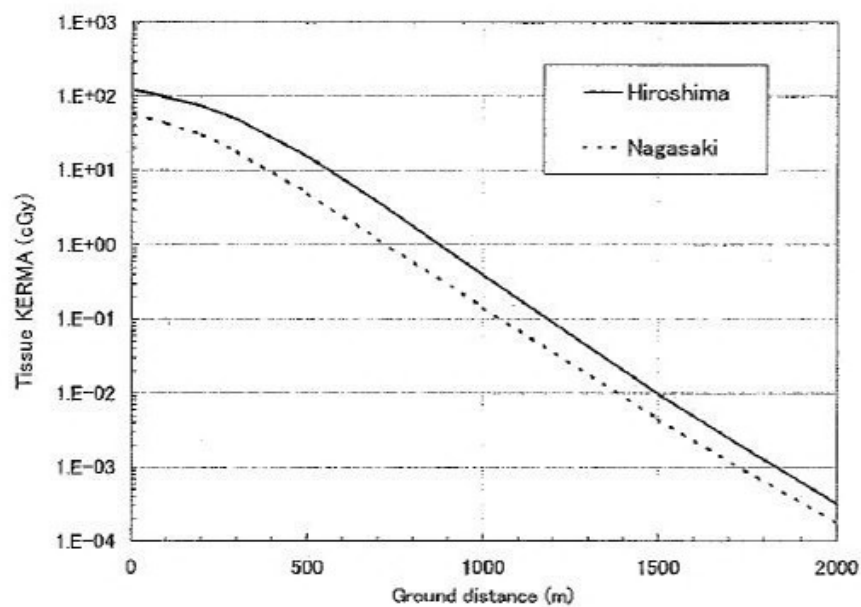
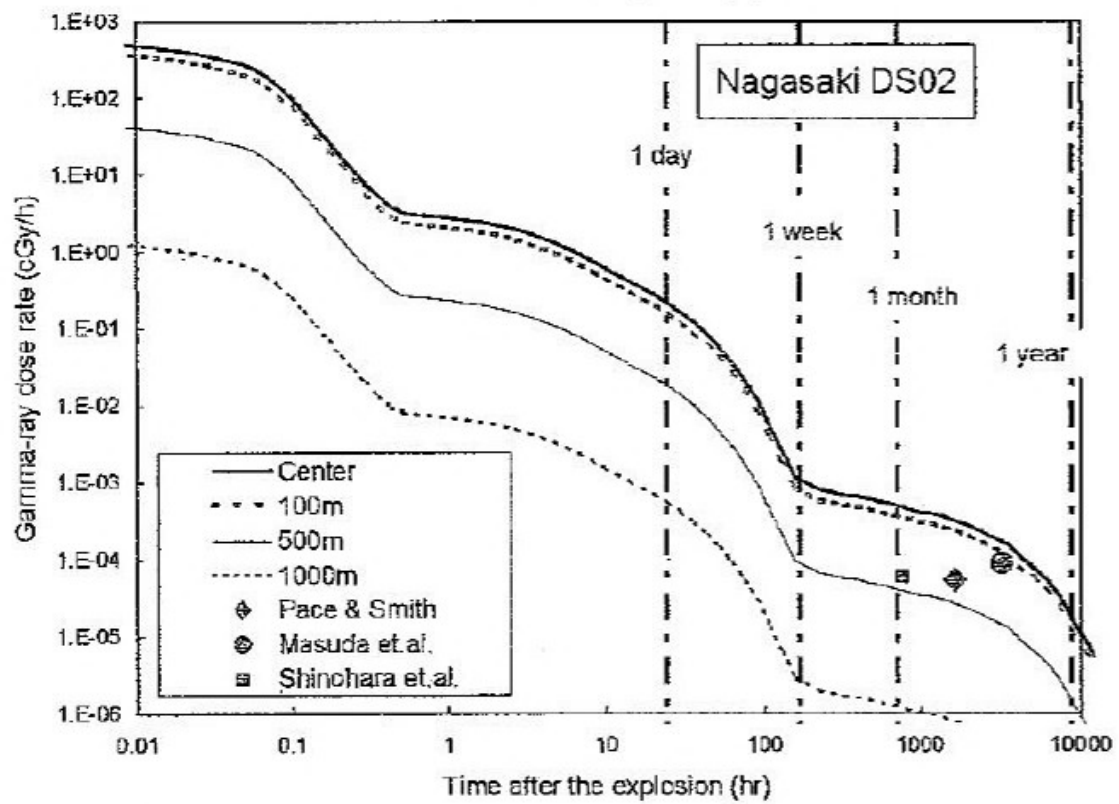
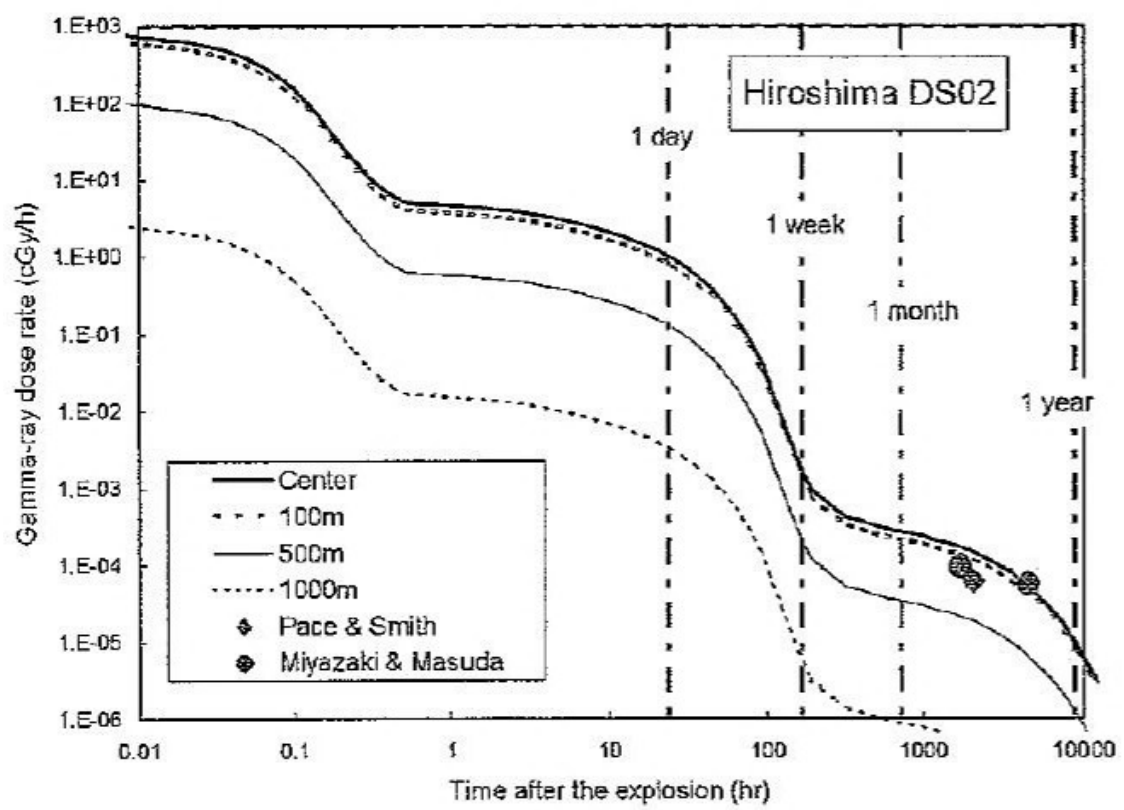

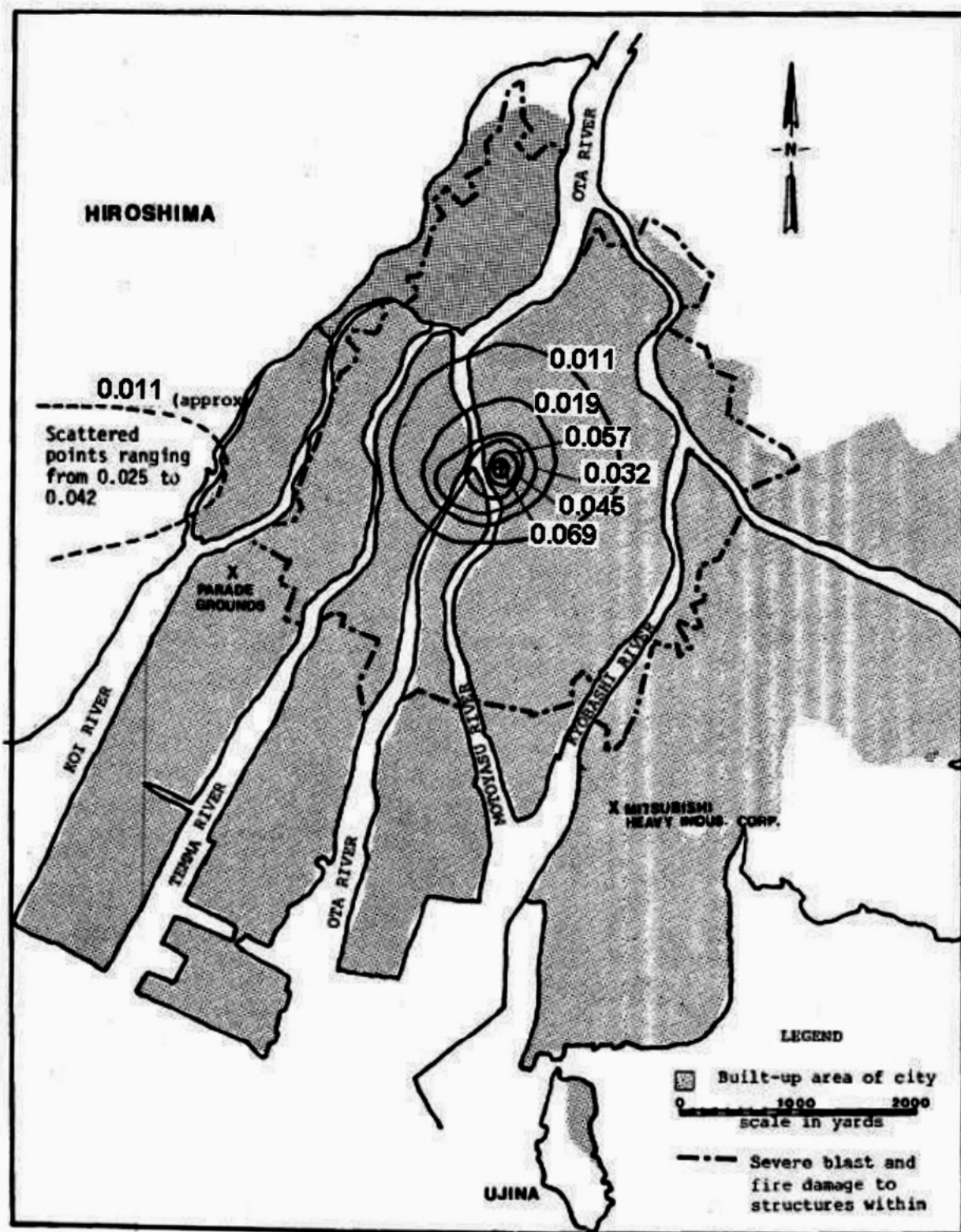

Results of the Naval Medical Research Institute (NMRI) survey performed in Hiroshima on November 1-2, 1945, showing residual radiation levels of 0.069 milliroentgen per hour (mR/hr) in the vicinity of ground zero and 0.011 mR/hr at the outermost contour. Source: DNA 5512F.

The NMRI survey report (Measurement of the Residual Radiation Intensity at the Hiroshima and Nagasaki Atomic Bomb Sites, NMRI-160A) documents a residual exposure rate of 0.081 mR/hr at the hypocenter, as well as spot measurements of 0 and 9 mR/hr among the "scattered points" to the west of the city center. These values are not represented on the map in DNA 5512F.

In Hiroshima, only 0.9% (17 burns) of 1,881 burns were due to ignited clothing, and only 0.7% (15 burns) were due to burns by firestorm flames!

**TABLE 8.3A**

*Number of Persons with Burns from Different Causes (Tokyo Imperial University's First Survey, October–November 1945)*

Distance from Hypocenter (km)	Secondary Burns†		Total Burns
	From Clothes on Fire	By Flame	
0.6–1.0	3 (3.3)		89
1.1–1.5		1 (1.1)	327
1.6–2.0	4 (0.5)	4 (1.2)	717
2.1–2.5		6 (0.8)	558
2.6–3.0	5 (0.8)	3 (0.5)	140
3.1–3.5	4 (2.8)	1 (0.7)	41
3.6–4.0	1 (2.4)		4
<b>Total</b>	<b>17</b> (0.9)	<b>15</b> (0.7)	<b>1,881</b>

\* Primary burns are burns by thermal rays from the A-bomb.

† Secondary burns are burns by fire other than thermal rays.

‡ Figures in parentheses are percentages of incidence.

Source: T. Kajitani and S. Hatano, "Medical survey on acute effects of atomic bomb in Hiroshima," in CRIABC vol. I, p. 522.

Note: there were 5 burns cases within 0.6 km, all primary

**TABLE 8.3B**

*Region of Burns*

	Head		Face		Neck		Total	
	Outdoors	Indoors	Outdoors	Indoors	Outdoors	Indoors	Outdoors	Indoors
Number of persons	179 (11.7)*	44 (12.3)	1,030 (67.4)	127 (35.7)	643 (42.1)	78 (21.9)	1,526	355
<b>Total</b>	<b>223</b> (11.8)		<b>1,157</b> (61.5)		<b>721</b> (38.3)		<b>1,881</b>	

\* Figures in parentheses are percentages of incidence.

Source: T. Kajitani and S. Hatano, "Medical survey on acute effects of atomic bomb in Hiroshima," in CRIABC vol. I, p. 522.

Above: extract from "Hiroshima and Nagasaki: The Physical, Social and Medical Effects", 1981 by the Japanese Committee for the Compilation of Materials on Damage Caused by Atomic Bombs

# SURVIVAL IN WOODEN AND CONCRETE BUILDINGS, HIROSHIMA

TABLE 7.3

Casualties among the Groups Exposed to the Atomic Bomb inside **Wooden** Houses, Hiroshima

Name of Building	Structure	Distance and Direction from Hypocenter (km)	Number Exposed	Mortality Rate (%)
Lodging for an itinerant theatrical troupe	Two-story	0.7 E	17	100.0
Second Hiroshima Army Hospital	Single-story	<b>1.0 N</b>	402	<b>75.3</b>

Source: Science Council of Japan, *Genshibakudan Saigai Chōsa Hōkokusho* [SRIABC] (Tokyo: Nihon Gakujutsu Shinkōkai, 1951), p. 25.

TABLE 7.4

Casualties among the Groups Exposed to the Atomic Bomb inside **Concrete** Buildings, Hiroshima

Name of Building	Structure	Direction and Distance from Hypocenter (km)	Number Exposed	Mortality Rate (%)
The Bank of Japan, Hiroshima Branch	three-story	0.4 SE	75	57.3
Broadcasting Station	two-story	<b>1.0 E</b>	31	<b>6.5</b>
Communication Bureau	four-story	1.4 N	245	6.1
Japan Red Cross Hospital, Hiroshima	three-story	2.0 S	480	0.4

\* While the total number of exposed is known, it has not been possible to determine how many died instantly or soon after the explosion. Source: Science Council of Japan, *Genshibakudan Saigai Chōsa Hōkokusho* [SRIABC] (Tokyo: Nihon Gakujutsu Shinkōkai, 1951), p. 26.

Above: extract from "Hiroshima and Nagasaki: The Physical, Social and Medical Effects", 1981



## About RERF

[Greetings](#)  
[Objective and History](#)  
[Organization](#)  
[Operations and Finance/Compliance with Laws](#)  
[Yearly Schedule](#)

## Research Activities

[Research Programs](#)  
[Active Research Protocols](#)  
[Ethics Committee](#)  
[Radiation Health Effects](#)  
[Views on Residual Radiation](#)  
[Highlights in Research Progress](#)  
[Partner Graduate Schools](#)

## Library

[Recent Scientific Papers](#)  
[List of Publications](#)  
[Webinar](#)  
[Downloadable Data](#)  
[Historical Materials](#)  
[Request for Publications](#)

## Community Access

[Getting to RERF](#)  
[Tour Reservations](#)  
[Inquiries](#)  
[Open House](#)  
[Request for Donations](#)  
[Procurement & Contracts](#)  
[Links](#)  
[Site Map](#)

## Search Site

[For further details](#)



[Top](#) > [Research Activities](#) > [Radiation Health Effects](#) > [Late effects on survivors](#) > Details

## Solid cancer risks among atomic-bomb survivors

Increased risk of cancer is the most important late effect of radiation exposure seen in A-bomb survivors. For cancers other than [leukemia](#) (solid cancers), excess risk associated with radiation started to appear about ten years after exposure. This was first noted by a Japanese physician, Gensaku Obo, in 1956, and it led to continuing comprehensive analyses of cancer mortality and to the creation of [tumor registries](#) by the city medical associations in both Hiroshima and Nagasaki.

For most solid cancers, acute radiation exposure at any age increases one's cancer risk for the rest of life. As survivors have aged, radiation-associated excess rates of solid cancer have increased as well as the background rates. For the average radiation exposure of survivors within 2,500 meters (about 0.2 Gy), the increase is about 10% above normal age-specific rates. For a dose of 1.0 Gy, the corresponding cancer excess is about 50% (relative risk = 1.5).

Tumor registries were initiated in 1957 in Hiroshima and 1958 in Nagasaki. During the period from 1958 to 1998, 7,851 malignancies (first primary) were observed among 44,635 LSS survivors with estimated doses of >0.005 Gy. The excess number of solid cancers is estimated as 848 (10.7%) (Table). The dose-response relationship appears to be linear, without any apparent threshold below which effects may not occur (Figure 1).

**Table.** Excess risk of developing solid cancers in LSS, 1958-1998

Weighted colon dose (Gy)	LSS subjects	Cancers		Attributable risk
		Observed	Estimated excess	
0.005 - 0.1	27,789	4,406	81	1.8%
0.1 - 0.2	5,527	968	75	7.6%
0.2 - 0.5	5,935	1,144	179	15.7%
0.5 - 1.0	3,173	688	206	29.5%
1.0 - 2.0	1,647	460	196	44.2%
>2.0	564	185	111	61.0%
Total	44,635	7,851	848	10.7%



## About RERF

[Greetings](#)  
[Objective and History](#)  
[Organization](#)  
[Operations and Finance/](#)  
[Compliance with Laws](#)  
[Yearly Schedule](#)

## Research Activities

[Research Programs](#)  
[Active Research Protocols](#)  
[Ethics Committee](#)  
[Radiation Health Effects](#)  
[Views on Residual Radiation](#)  
[Highlights in Research Progress](#)  
[Partner Graduate Schools](#)

## Library

[Recent Scientific Papers](#)  
[List of Publications](#)  
[Webinar](#)  
[Downloadable Data](#)  
[Historical Materials](#)  
[Request for Publications](#)

## Community Access

[Getting to RERF](#)  
[Tour Reservations](#)  
[Inquiries](#)  
[Open House](#)  
[Request for Donations](#)  
[Procurement & Contracts](#)  
[Links](#)  
[Site Map](#)

[Top](#) > [Research Activities](#) > [Radiation Health Effects](#) > [Late effects on survivors](#) > Details

## Leukemia risks among atomic-bomb survivors

Excess leukemia was the earliest delayed effect of radiation exposure seen in A-bomb survivors. Japanese physician Takuso Yamawaki in Hiroshima first noted an increase of leukemia cases in his clinical practice in the late 1940s. This led to the establishment of a registry of leukemia and related disorders and to the initial reports on elevated leukemia risks published in the early 1950s.

Risks for radiation-induced leukemia differ in two major respects from those for most solid cancers. First, radiation causes a larger percent increase in leukemia rates (but a smaller number of cases since leukemia is relatively rare, even in heavily exposed survivors), and second, the increase appears sooner after exposure, especially in children. The excess leukemias began appearing about two years after radiation exposure, and the excess peaked at about 6-8 years after exposure. Today, little if any excess of leukemia is occurring.

Because the [Life Span Study](#) (LSS) cohort was based on the 1950 national census, quantitative descriptions of leukemia risks in A-bomb survivors have been based on cases diagnosed from that year on. As of the year 2000, there were 204 leukemia deaths among 49,204 LSS survivors with a bone marrow dose of at least 0.005 Gy, an excess of 94 cases (46%) attributable to A-bomb radiation (Table). In contrast to dose-response patterns for other cancers, that for leukemia appears to be nonlinear; low doses may be less effective than would be predicted by a simple linear dose response. Even for doses in the 0.2 to 0.5 Gy range, however, risk is elevated (Figure 1).

**Table.** Observed and estimated excess number of leukemia deaths in LSS population, 1950-2000

Weighted marrow dose (Gy)	Subjects	Deaths		Attributable risk
		Observed	Estimated excess	
0.005 - 0.1	30,387	69	4	6%
0.1 - 0.2	5,841	14	5	36%
0.2 - 0.5	6,304	27	10	37%
0.5 - 1.0	3,963	30	19	63%
1.0 - 2.0	1,972	39	28	72%
>2.0	737	25	28	100%
Total	49,204	204	94	46%

relative risk (ERR) and the right panel excess absolute risk (EAR).

### References about this subject

- Preston DL, Shimizu Y, et al.: Studies of mortality of atomic bomb survivors. Report 13. Solid cancer and noncancer disease mortality: 1950-1997. *Radiation Research* 2003; 160:381-407
- Preston DL, Ron E, et al.: Solid cancer incidence in atomic bomb survivors: 1958-1998. *Radiation Research* 2007; 168:1-64
- Preston DL, Pierce DA, et al.: Effect of recent changes in atomic bomb survivor dosimetry on cancer mortality risk estimates. *Radiation Research* 2004; 162:377-89
- Ron E, Preston DL, et al.: Cancer incidence in atomic-bomb survivors. Part IV: Comparison of cancer incidence and mortality. *Radiation Research* 1994; 137:98-112

**Radiation risks from nuclear explosions in Hiroshima and Nagasaki were insignificant and smaller than those from natural background cancer rates, except for leukemia in people receiving over 1000 millisieverts (equal to 1 sievert, or 100 rems), where the leukemia death rate was 3.5% of which 2.4% was radiation exposure induced. Natural cancer deaths = 11%.**

Dose range milli-sievert	Number in 1950	Cancer deaths (excl. leukaemia)		Leukaemia deaths	
		total rate	rate from radiation	total rate	rate from radiation
Less than 100	68467	11.2%	0.09%	0.2%	0.01%
100 to 200	5949	12.3%	0.7%	0.2%	-0.01%
200 to 1000	9806	13.2%	1.9%	0.6%	0.3%
More than 1000	1829	24.1%	8.1%	3.5%	2.4%
<b>All</b>	<b>86611</b>	<b>11.7%</b>	<b>0.6%</b>	<b>0.3%</b>	<b>0.1%</b>

*Table 1. Cancer deaths among 86611 Hiroshima and Nagasaki survivors, 1950-2000, separated by dose bands<sup>5</sup>(Preston et al 2004). The total radiation-related deaths from solid cancer and leukaemia were 480 and 93, respectively. The rates highlighted in green are consistent with zero, statistically.*

5 Preston, Dale L. et al (2004) Radiation Research. 162: 377–389.

<http://www.bioone.org/doi/abs/10.1667/RR3232>



# Hiroshima

## TOTAL MORTALITY VERSUS PEAK OVERPRESSURE IN NAGASAKI

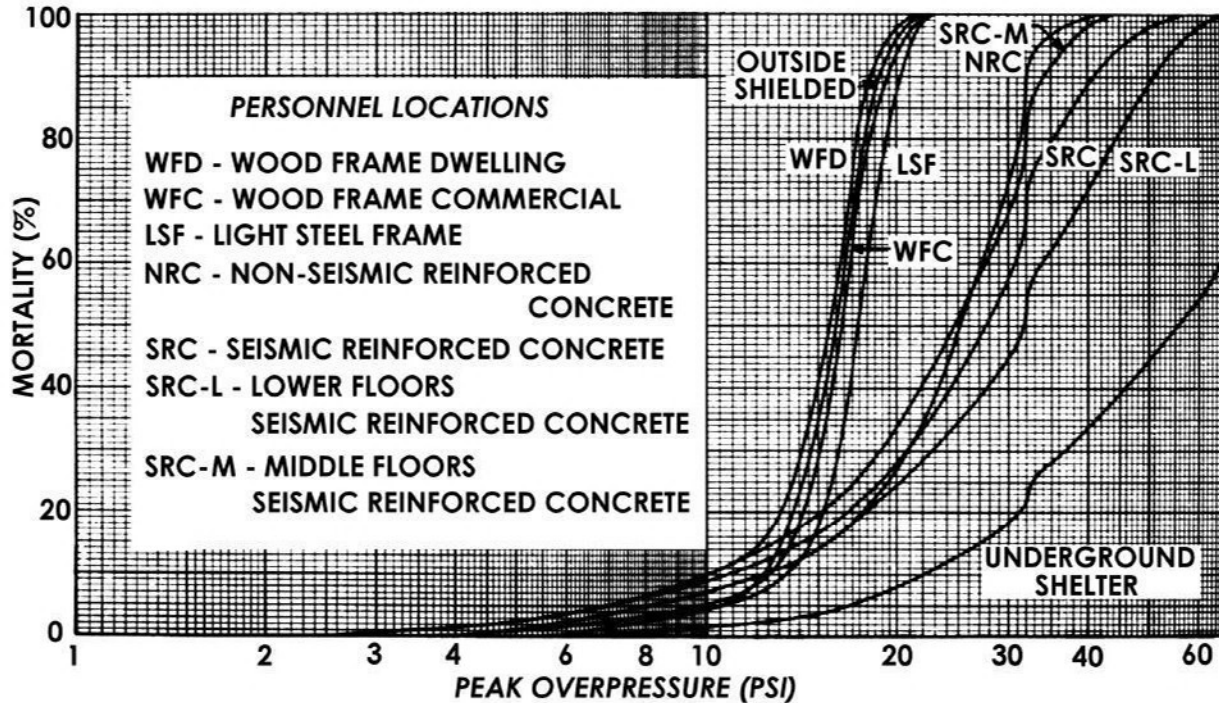

## TOTAL MORTALITY VERSUS PEAK OVERPRESSURE IN HIROSHIMA

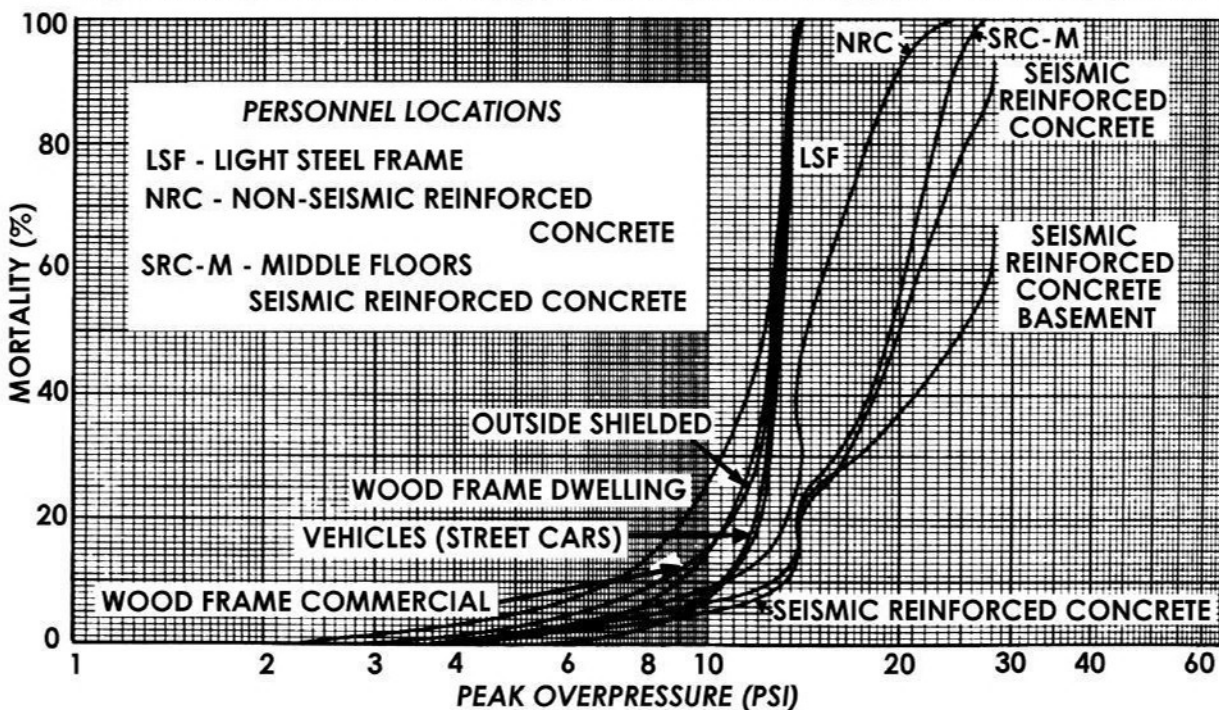

## MORTALITY AS A FUNCTION OF TIME AFTER NUCLEAR ATTACK ON HIROSHIMA

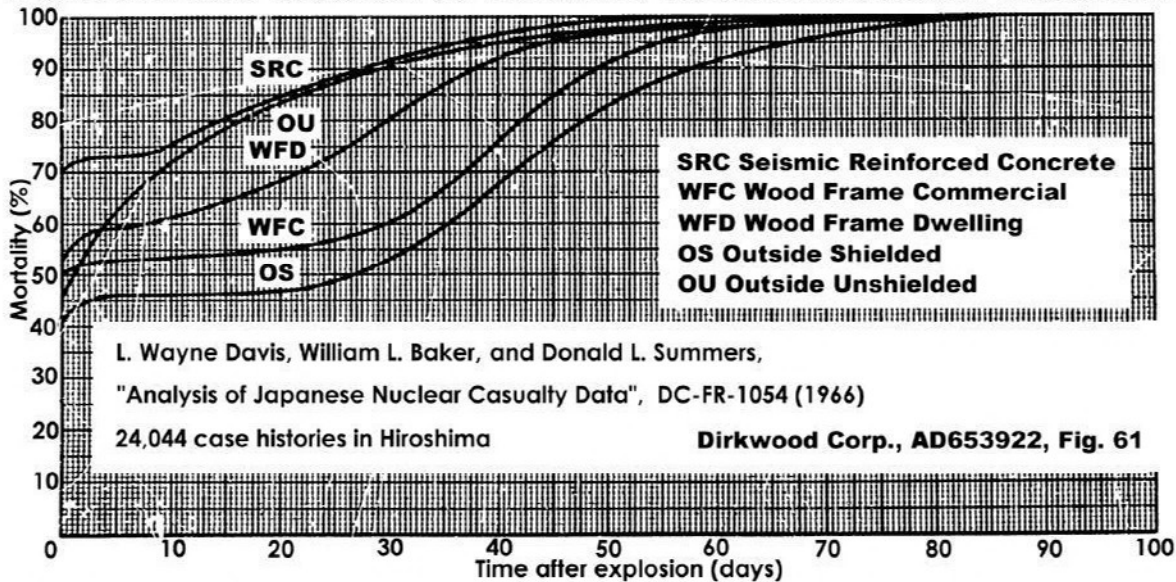

Left: the Dirkwood Corporation analysis of the mortality rates as a function of peak overpressure in Nagasaki and Hiroshima is based on 24,044 traced case histories in Hiroshima and 11,055 in Nagasaki (a total of 35,099 cases). The report by L. Wayne Davis, William L. Baker, and Donald L. Summers, *Analysis of Japanese Casualty Data*, DC-FR-1054, AD653922 (1966), summarises the effects versus distance.

A classified report by L. Wayne Davis, et al., *Prediction of Urban Casualties and the Medical Load from a High-Yield Nuclear Burst*, Dirkwood Corporation paper DC-P-1060 (1968), compares the peak overpressures for the casualties in each city to those from the main Texas City Disaster surface burst explosion of 1947, when 0.67 kt of explosive in a ship detonated after a fire. (This is corrected for the effective explosion energy, which was less than the total mass of explosive involved because some was on a nearby dock and did not explode simultaneously, and some burned without detonating.) Comparison of mortality versus peak overpressure curves for different events shows the influence of nuclear radiation and the firestorm at Hiroshima on total casualty rates.

# Hiroshima



*Above:* building 18 (the 7-story Fukoku department store building), survived 20 psi peak overpressure blast at just 329 m from ground zero in Hiroshima. It burned hours later.



*Above right:* building 5, located at just 193 m from ground zero Hiroshima. Designed to survive a lateral load of 10% of its weight (Japanese minimal safety standard legislation).



*Above:* 3-story concrete building 792 m west of ground zero Hiroshima. Firebrands entered through broken windows.



*Above:* the Hiroshima Electric company building 644 m south. It was soon reoccupied despite suffering fire damage.



# Hiroshima

## DIRECT EFFECTS OF 1 MT SURFACE BURST

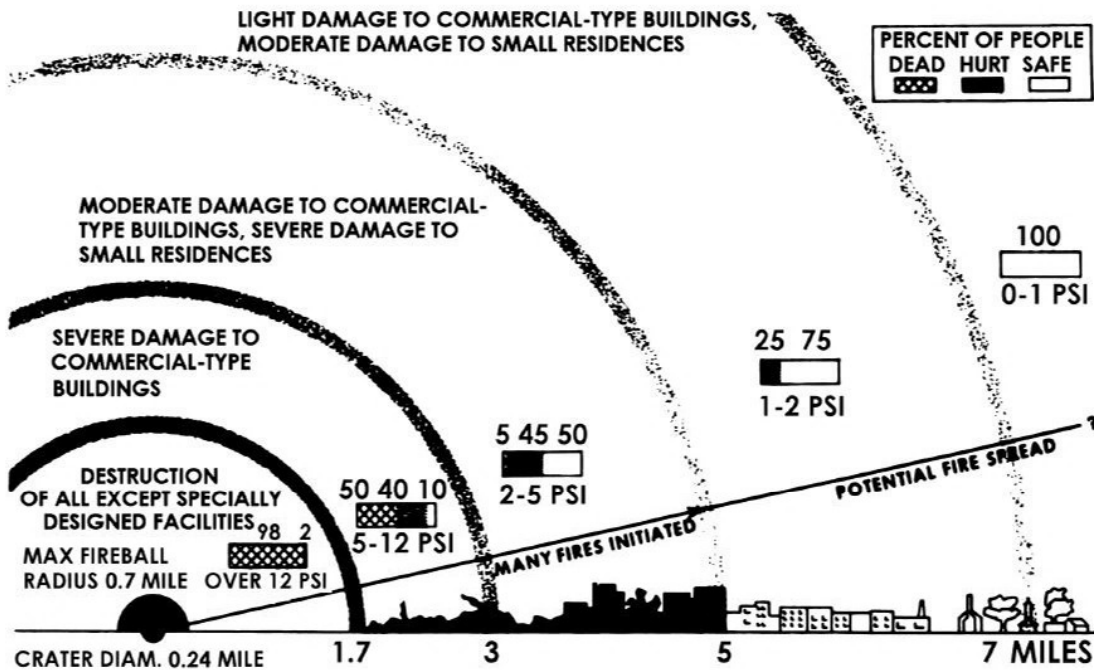

Left: the 1973 U. S. Department of Defense *DCPA Attack Environment Manual* provided this casualty-versus-peak overpressure analysis, associating the 5-12 psi peak overpressure zone with 50 mortality, without source references. It was used to for *grossly deceptive exaggeration, ignoring civil defence effectiveness* by the 1979 U. S. Office of Technology Assessment study, *The Effects of Nuclear War*. Deceptions were excluded from public scrutiny, debate and analysis by deliberately assigning reports secret and/or "limited distribution" (ostensibly to keep it from Moscow).



**BANK OF JAPAN, HIROSHIMA (BUILDING 24)**

Left: 50% of 100 people survived inside the concrete Bank of Japan (building 24 in Hiroshima, in the U. S. Strategic Bombing Survey report) at a peak overpressure of 18 psi, just 390 metres from ground zero in Hiroshima. This was well inside the "firestorm" area, and only 7.5 m from the nearest burning building. A second floor fire, due to a firebrand blown through a broken window, was extinguished by the survivors using water fire buckets at 1.5 hours after the nuclear explosion. Note 3rd floor windows soot.

The evacuated 3rd floor suffered a firebrand ignition, which was discovered too late to extinguish, and burned *without spreading to lower floors*. (Source: *DCPA Attack Environment Manual*, Chapter 3, Panel 26, 1973. The U. S. Strategic Bombing Survey report shows that it had 12 inch thick reinforced concrete walls and 20 inches of sand on the roof.)



**GEIBI BANK COMPANY, HIROSHIMA (BUILDING 18)**

Left: the Geibi Bank building (building 18) after it survived 8 psi peak overpressure at 293 metres from ground zero in Hiroshima, again inside the "firestorm" area. It survived fire completely; firebrands blown in through first and third floor broken windows at 2.25 hours after the explosion ignited curtains and furniture but these fires were extinguished by survivors using water fire buckets. (The U. S. Strategic Bombing Survey reported it had 10 inch reinforced concrete walls.)

# Hiroshima

THermal SHADOWING (BEFORE BLAST ARRIVAL)  
SHADOWED FRACTION OF WINDOWS FACING THE FIREBALL

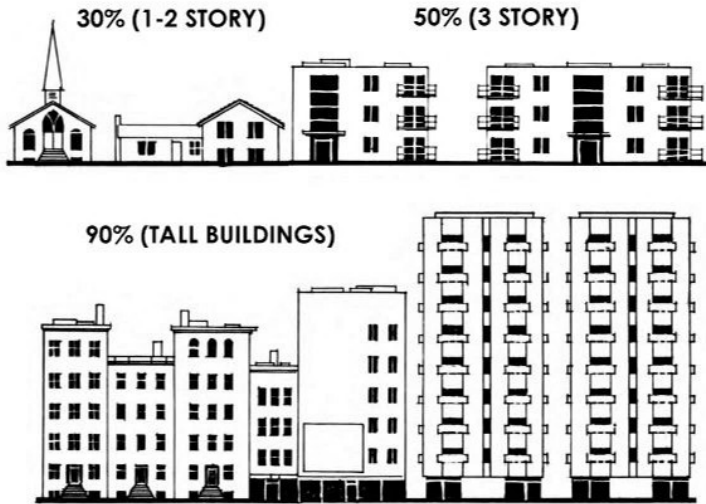

SOURCE: FEMA ATTACK ENVIRONMENT MANUAL (1982)

LOW YIELD WEAPONS (SHORT BLAST WIND DURATION)

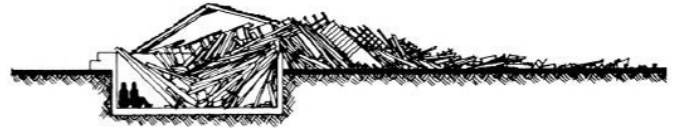

HIGH YIELD WEAPONS (LONG BLAST WIND DURATION)

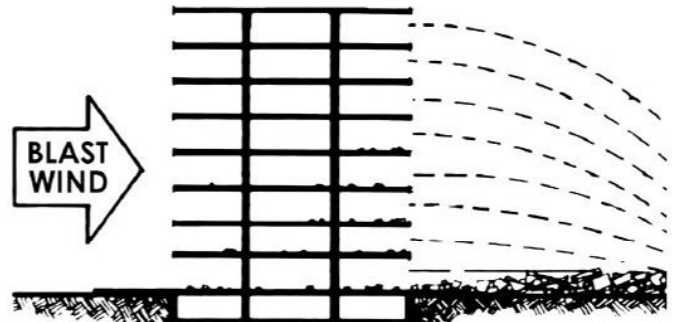

Above: for any particular peak overpressure, the duration of the blast winds and accompanying "dynamic" (wind) pressure is proportional to the cube-root of the explosion yield. A megaton yield weapon exerts the same overpressure and dynamic (wind) forces at a given peak overpressure as a low yield weapon, but the time these forces last for is greater. This reduces the vertical load falling on people lying flat to avoid horizontal wind drag and the wind-carried debris. Therefore, although the wind speed and the dynamic pressure are independent of weapon yield (for a given peak overpressure), they last longer if the explosion yield is increased, so debris is spread over a wider area. This does not affect the peak velocity attained by small pieces of debris, which quickly attain their peak velocity in the blast wind regardless of the duration of the blast. However, it does affect the time they are blown by the blast wave, and therefore the distance they travel.

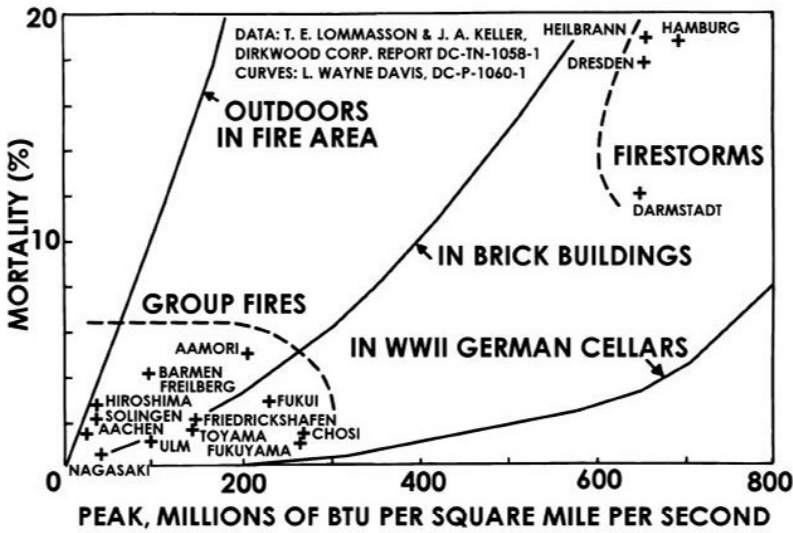

Above: nuclear explosions do not provide burning fuel like incendiary air-raids on wooden cities, and hijacked aircraft hitting the Twin Towers on 11 September 2001 (where burning aviation fuel melted the steel frame). At Hiroshima, shadowing protected most window contents.

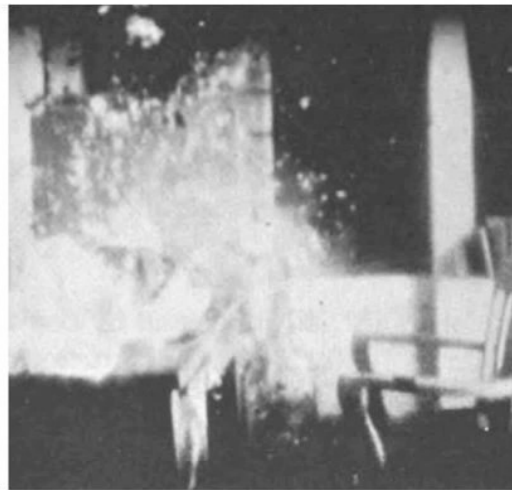
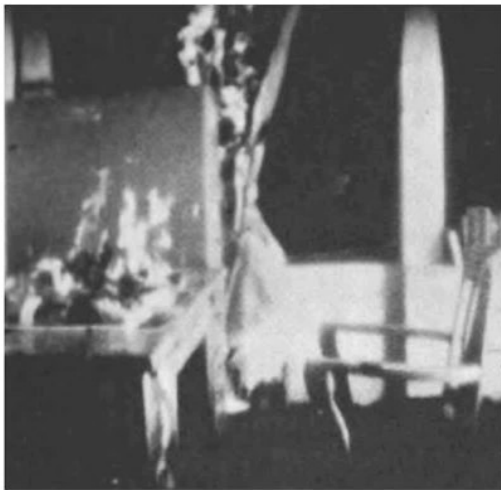

Above: 1 psi peak overpressure extinguishing paper and curtain fires, like a match in a 70 miles per hour wind (source: T. Goodale, *Effects of Air Blast on Urban Fires*, URS 7009-14, 1970). The mechanism for the blast to extinguish fires is simple: hurricane winds cool the fuel below its ignition temperature, putting the fire out. This is a much bigger problem of lighting a match in a very strong wind. This mechanism put out 50% of Goodale's curtain fires at 1 psi, and 100% at >2.5 psi, but it did not operate with red hot lumps of charcoal in Hiroshima's breakfast braziers or with pans of burning oil in other blast tests, because the lip of the pan shelters the hot surface

of the fuel from the cooling blast wind. The blast winds do not blow out hard-to-ignite thick fuels like mattresses and *Encore*-type cotton-padded furniture, where the structure itself protects the hot interior fuel from exposure to the cooling blast winds. In one room at the *Encore* nuclear test of 1953 the wall around the window shielded burning rubbish from the cooling blast winds. The U. S. Strategic Bombing Survey found at Hiroshima that although 107 of the 130 large buildings surveyed eventually burned, only 20% were ignited within 30 minutes of the nuclear explosion, so people escaped fires (source: FEMA Attack Environment Manual, 1982).

# Hiroshima

## HIROSHIMA MORTALITY AND CASUALTY RATES WOODEN AND CONCRETE BUILDINGS COMPARED

Figure 11

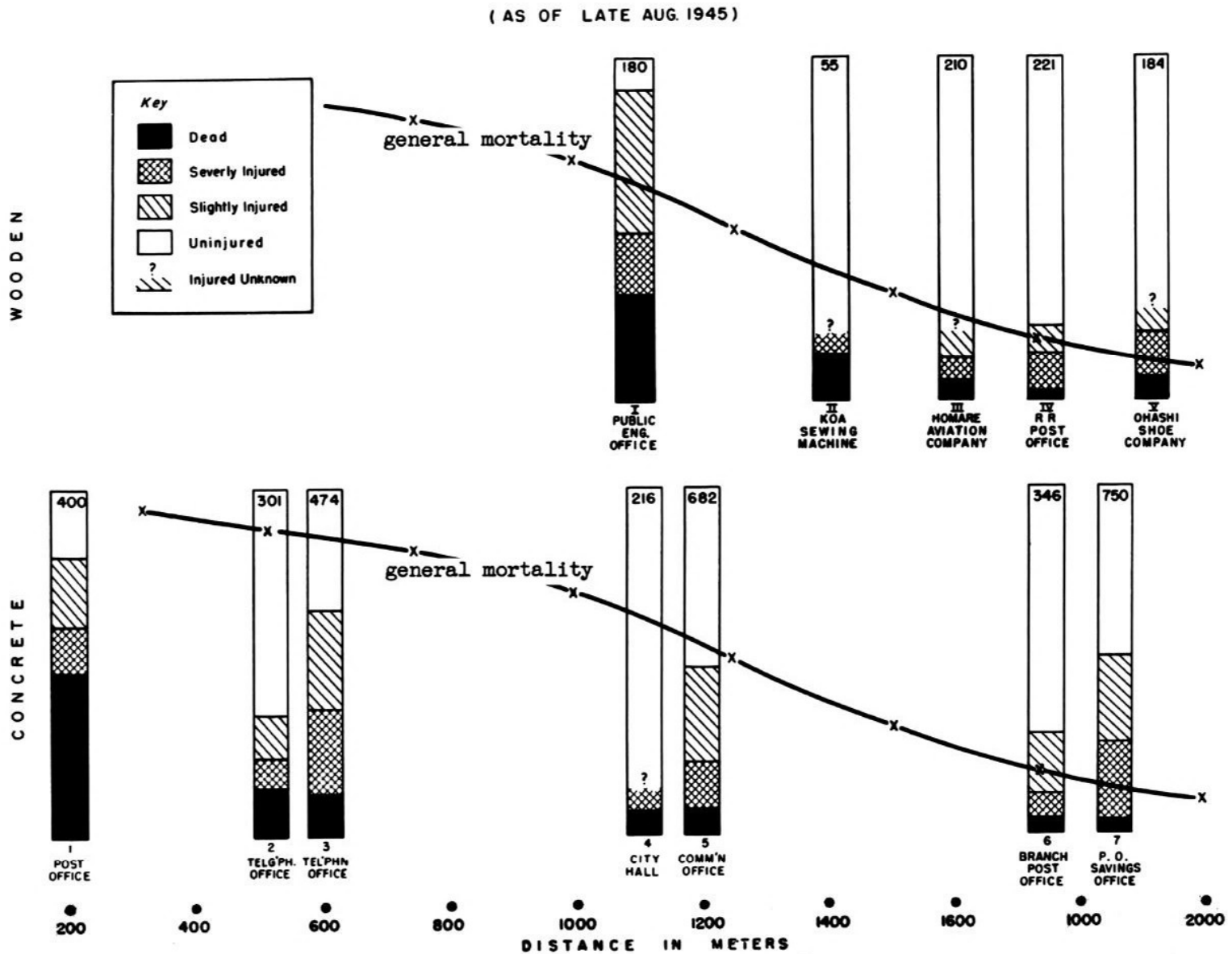

Above: Fig. 12 from Ashley W. Oughterson, et al., *Medical Effects of Atomic Bombs: The Report of the Joint Commission for the Investigation of the Effects of the Atomic Bomb in Japan*, Volume VI, U. S. Army Institute of Pathology, NP-3041, 1951, comparing the overall general mortality for Hiroshima with the mortality inside wooden and concrete buildings. *Hiroshima's obsolete wooden houses had a higher mortality than concrete buildings.*

by which time most survivors had evacuated, so *the fire damage in concrete buildings did not determine casualty rates* (e.g., 207 out of 400 people *survived* in Hiroshima's Post Office, burned-out just 200 metres from ground zero).

Glasstone and Dolan's Table 12.21 correlates "severe damage" to 88% killed in the two reinforced concrete buildings right next to ground zero in Hiroshima.

Table 12 of that report is the basis of most of the data in Table 12.21 on page 547 of the 3rd edition (1977) of Glasstone and Dolan's book, *Effects of Nuclear Weapons*, which averages Hiroshima survival data for concrete buildings and correlates it to "degrees of damage," not distance. *This correlation can be deceptive, because some casualties in concrete buildings were not due to blast effects, but due to nuclear radiation, which predominated on the upper floors, where there was less shielding from the air burst overhead than for the lower floors.* Most fire damage to these buildings occurred 2-3 hours later at the height of the firestorm,

To correlate "moderate damage" to 14% mortality (106 killed out of 775 people), Glasstone and Dolan average NP-3041's Table 12 data for Hiroshima's Telegraph Office at 500 metres (301 occupants, 45 killed) and the Central Telephone Office at 600 metres (474 occupants, 61 killed). Glasstone and Dolan's correlation of "light damage" to 8% killed is NP-3041's Table 12 for Hiroshima City Hall at 1.1 km (216 occupants, 18 died up to 10 November 1945) and the Communications Office at 1.2 km (682 occupants, 56 killed). *These data only apply to an unwarned population inside concrete buildings.*

# Hiroshima

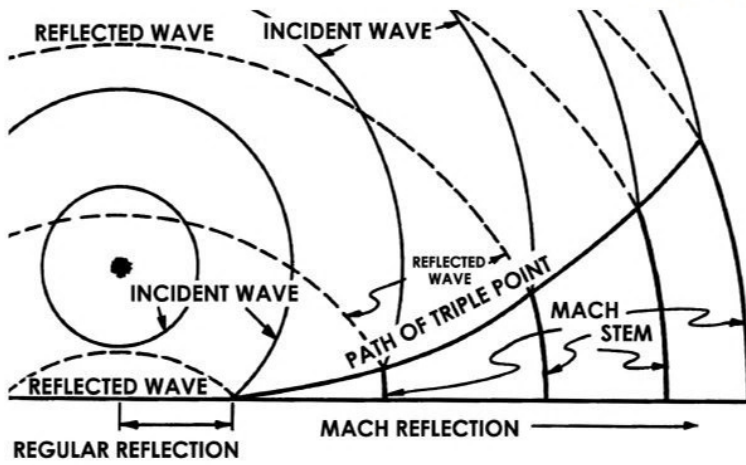

Above: in any air burst explosion over a surface, the downward blast wave reflects off the ground, so at locations near ground zero and above the ground surface two blast waves are felt: the direct (incident) blast moves radially outwards the detonation point, and is soon followed by the upward-moving ground reflected blast wave which moves radially outwards from an imaginary mirror point which is located at one burst altitude below ground zero. But this simple mirror-like "regular reflection" only applies to distances within a ground radius equal to about the height of burst.

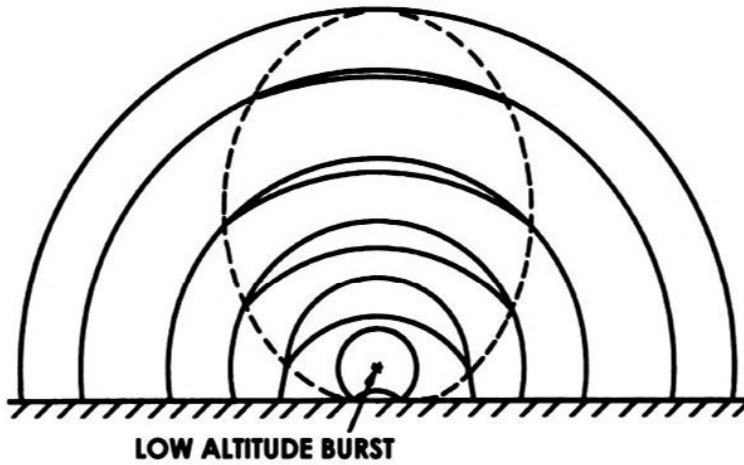

At greater distances, the ground-reflected blast wave, moving faster than the direct blast wave (because it moves through air which has been heated by the direct blast wave), catches up with the direct blast wave and rapidly merges to form a fused blast wave. This fused blast wave is sometimes called the "Mach stem," and it has a height which rapidly grows with distance from ground zero, but rapidly decreases with increasing burst altitude. For a 1 kt air burst at height  $H$  feet, the Mach stem height at ground distance  $R$  feet is given by approximately  $(R - H)^2 / (R + 7.4 \times 10^{-5} H^3)$  feet  $\pm 20\%$ , for distances  $R > H$ , since the Mach stem only begins to form at a distance from ground zero

similar to the burst altitude. (Our equation is based on the Mach stem height graphs in TM 23-200 and DNA-EM-1. For yields over  $W = 1$  kt, all heights and distances should scale up in proportion to  $W^{1/3}$ .)

A similar fusion of direct and ground reflected blast waves will occur *above the fireball region* if the burst height is less than  $160W^{1/3}$  feet  $\pm 15\%$  where  $W$  is the standard (total) weapon yield in kilotons, simply because the ground-reflected blast wave is greatly speeded up while it is travelling through the extremely hot fireball (TM 23-200 and DNA-EM-1).

The Mach stem's peak overpressure is doubled by energy added to the direct wave by fusion with the ground reflected wave (ignoring energy losses due to "air slap"-type ground shock), causing a "knee" in graphs of peak overpressure versus distance. Using the cube-root scaling law, this doubling of energy in the Mach stem increases distances for overpressures by a factor of  $2^{1/3} = 1.26$ . But this is smaller than the measured Mach wave pressure enhancements in nuclear tests. Penney's AWRE team measured the various enhancements in British nuclear tests over surfaces of different colours, and chemical explosion air bursts over concrete. Penney argues in his 1970 paper on the Hiroshima and Nagasaki blasts that thermal flash energy absorbed by a surface convectively heats air, so the surface Mach region engulfs a considerable fraction of the downward-directed thermal pulse energy, at distances where the arrival times of the blast wave correspond to the emission of a large fraction of the thermal flash from the fireball.

At most 50% of the thermal flash energy in an air burst (that travelling downward, for a dark coloured surface) can be convectively transferred to the air just above the surface, but since this energy is added to only a small fraction of the complete volume of the blast wave, this pressure enhancement by cumulative engulfment of hot air over desert is greater than the enhancement due to the blast wave fusion in the Mach stem. The graph below shows the progressive thermal enhancement from engulfed hot air.

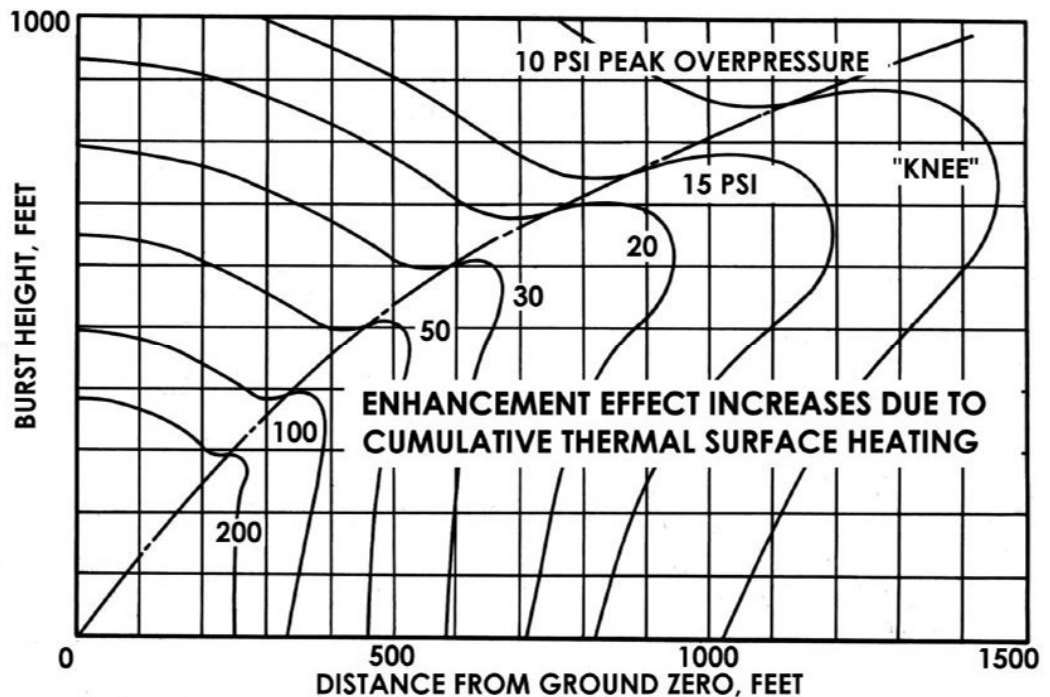

Right: peak overpressures from 1 kt yield Nevada nuclear air bursts (DASA-1200).

# Hiroshima

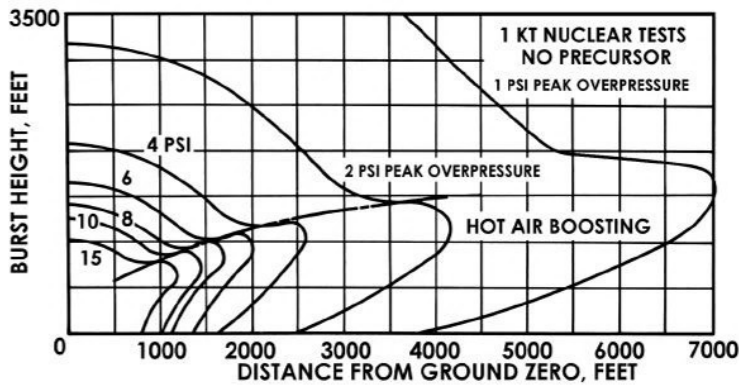

Above: peak overpressures from 1 kt yield Nevada nuclear air bursts (DASA-1200, and Glasstone and Dolan 1977). The 1 psi peak overpressure Mach stem from a 1 kt air burst at 1,500 feet altitude stretches out to 7,000 feet from ground zero, compared to just 4,000 feet for a surface burst (where the direct and ground reflected blast waves also fuse into a single Mach wave. This factor of 1.75 increase shows that  $1.75^3$  or 5.36 times more energy is present in the air burst blast wave, which is caused by surface hot air, due to the thermal flash heating in Nevada (50 miles visibility).

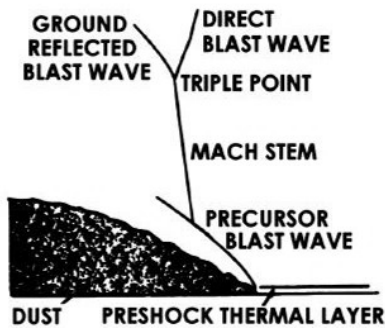

Penney's 1970 paper debunks the basic predictions of the blast effects of nuclear weapons, because the cube-root scaling law does not apply to thermal radiation heating enhancement effects on blast (neither thermal energy delivery times nor thermal energy delivery scale by the cube-root of yield).

Additionally, any thermal enhancement will be subjected to attenuation by weather like cloud and fog between the detonation altitude and the surface, and in any case differently coloured surfaces will heat up to a differing extent, causing different amounts of enhancement to the peak overpressure. White concrete surfaces will reflect more of the thermal pulse away from the surface, but dark surfaces will heat up to very high temperatures on the ground in the proximity to a nuclear air burst, which convectively heats a "preshock thermal layer" of air.

However, if the surface sand contains water of mineralization, this water breaks up or "popcorns" the sand crystals into dust when sufficiently scorched by the thermal flash, and a hurricane strength sandstorm races ahead of the main shock wave in what is called the "precursor," which actually reduces the peak overpressure while the dynamic (wind) pressure impulse is enhanced due to the kinetic energy of the dust. A precursor wind blew hot dust into the open entrances of hillside tunnel shelters in Nagasaki, causing skin burns to personnel. Compressed air refracts light, distorting scenes and in a clear sky smoke trails from rockets can be laid down before burst to allow the Mach stem height and precursor to be filmed in nuclear tests. A precursor was first photographed in the 1952 *Tumbler-4* Nevada test. Precursors only formed in bursts low enough ( $<650W^{1/3}$  feet, where  $W$  is yield in kt; TM 23-200, Fig. 2-17) to popcorn sand. *Upshot-Knothole-9*, 26 kt at 2,400 ft, formed no precursor.

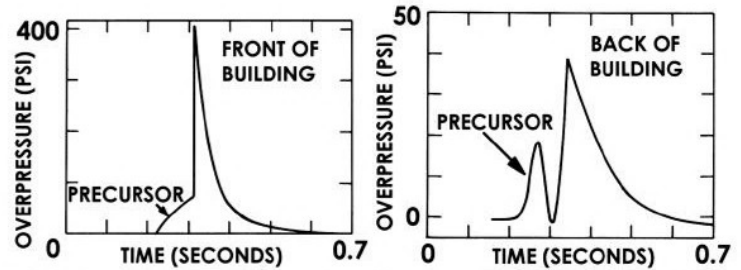
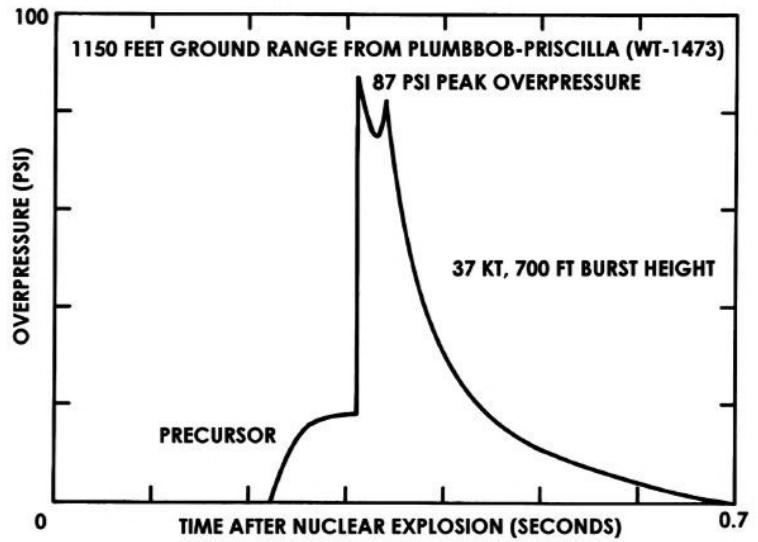

10 X 11 X 17 FOOT BLOCKHOUSE BUILDING, 1150 FEET GROUND RANGE FROM 37 KT PLUMBBOB-PRISCILLA 700 FEET HEIGHT AIR BURST IN NEVADA PEAK OVERPRESSURE IN MACH STEM = 87 PSI (SOURCE: WT-1473)

Above: the total overpressure loading on the front and back of a rigid concrete blockhouse. The free field peak overpressure was 87 psi, which increased to over 400 psi when the shock wave reflected at normal incidence on the front face of the building (a head-on collision). The basic reflection effect doubles the pressure, but there is an additional increase in strong shock waves from the conversion of the windpressure into overpressure (the horizontal component of the wind is stopped a head on collision with a rigid surface, converting it into additional overpressure). On the back of the building the peak overpressure was under 40 psi.



Above: the 15 kt *Upshot-Knothole Grable* air burst at 524 feet in 1953, a 280 mm diameter nuclear cannon shell (gun assembly using U-235 to avoid preinitiation from the high spontaneous fission rate in plutonium), produced a very hot preshock thermal layer:

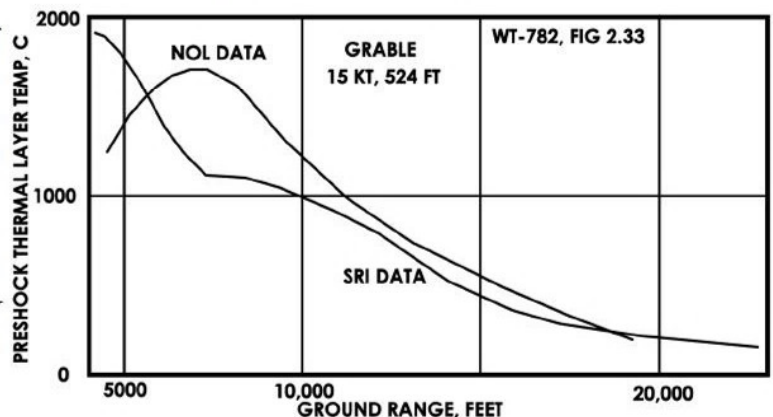

# Hiroshima

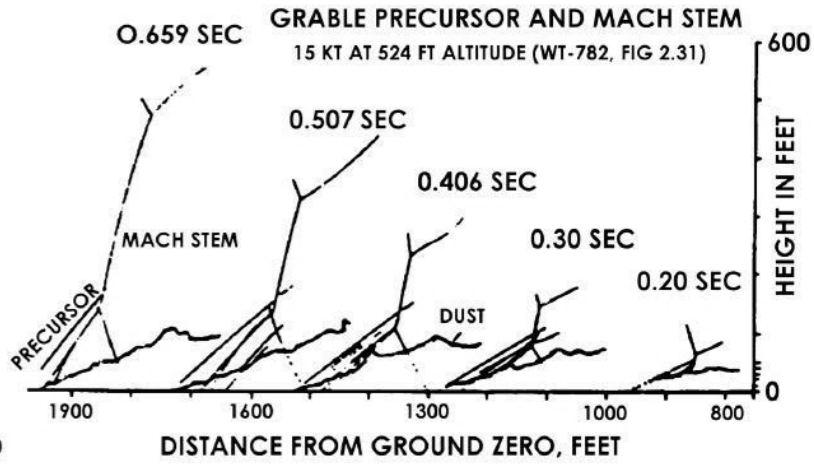
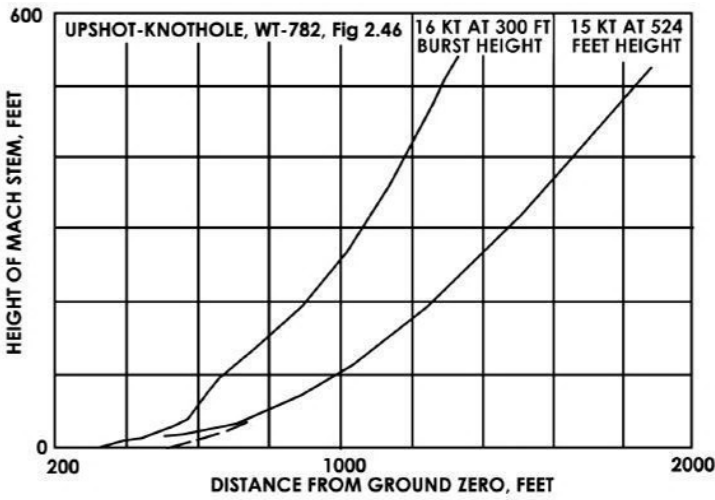

Above: the Mach stem height and precursor height are vitally important in air bursts, because these phenomena only occur over a certain range of heights in an air burst. Increasing the height of burst considerably reduces the Mach stem height at a fixed distance. If the height of the Mach stem is lower than the building it encounters, only the floors below the Mach stem height will be subject to a single, horizontally-moving shock wave, and

higher floors will experience two shock waves. In the latter case, the direct wave comes radially (on a downward slant) from the detonation point, but the ground-reflected shock wave comes on an upward slant from a mirror point one burst height below ground. These non-horizontal angles of incidence reduces the horizontal wind or dynamic pressure component, as compared to the Mach wave. The vertical wind does not blow things sideways.

## DYNAMIC AND OVERPRESSURE PRECURSOR BLAST WAVEFORMS 2000 FEET FROM GROUND ZERO, GRABLE, NEVADA (15 KT 524 FT AIR BURST)

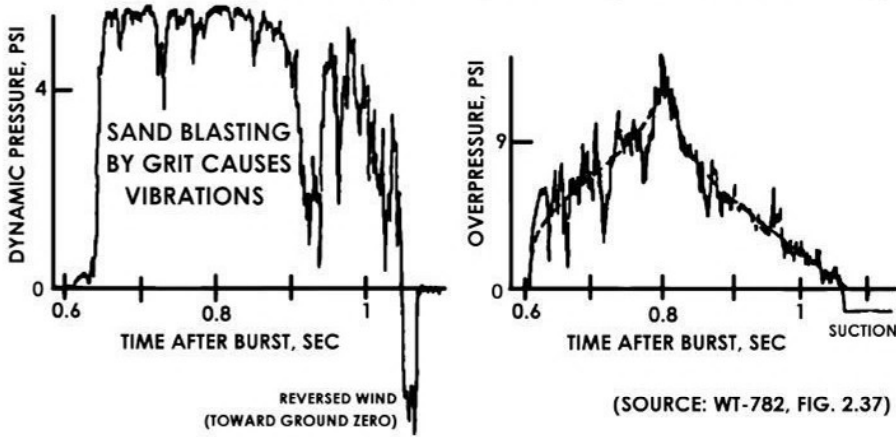

MEASUREMENTS AT 10 FEET HEIGHT (PRECURSOR WAS SLIGHTLY WEAKER AT 40 FEET HEIGHT)

Above: the most important effects of the precursor on overpressure and dynamic pressure are changes in the waveform shape, not the change in the peak pressure. Examples are shown for the 1953 Grable test, a 15 kt burst detonated at a height of 524 feet over Nevada desert sand. The waveforms for both overpressure and dynamic pressure at 1,419-2,000 feet are completely dominated by the precursor "sandstorm," with jagged fluctuations due to pressure sensor vibrations from impacts of dust, sand, grit, and small stones during sandblasting. At 2,000 feet (above left), the dynamic pressure remains near its peak value for most of the positive phase, instead of falling rapidly after a spiked peak, which occurs when no precursor is present (compare the graphs above

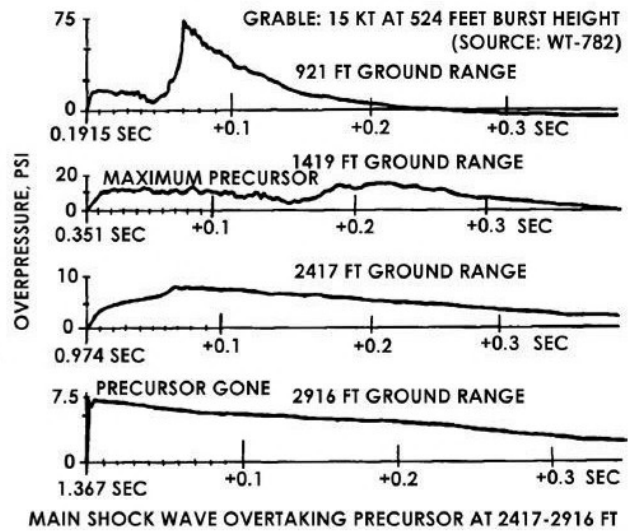

to "ideal" blast waveforms, below). Consequently, the dynamic pressure impulse (dynamic pressure integrated over time) is greatly increased in a precursor for a given fixed peak pressure.

An example of the role of the precursor's dynamic pressure impulse in damaging wind drag-sensitive targets is the effect of the Grable precursor on World War II jeeps. On the previous test, *Encore*, where there was no precursor, jeeps were rolled up to 11 metres and moderately damaged. But for a similar peak overpressure, the precursor of Grable caused severe damage or the complete destruction of jeeps, with chassis, engine and wheel debris blown for distances of over 300 m (ref.: DNA-5826F, p. 2).

Right: the "ideal" overpressure at time  $t$  after blast arrival in a free air burst is

$$p_t \approx p(1 - t/t_p^+) / (1 + 0.1pt/t_p^+),$$

where  $p$  is the peak overpressure in psi, and  $t_p^+$  is the overpressure (positive phase) duration. The "ideal" dynamic pressure  $q_t$  falls even faster with time:  $q \approx 2.5p^2 / (p + 7P_0)$ , where  $P_0$  is ambient atmospheric pressure.

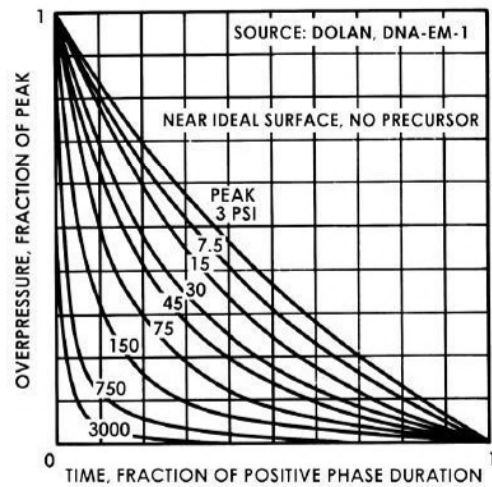
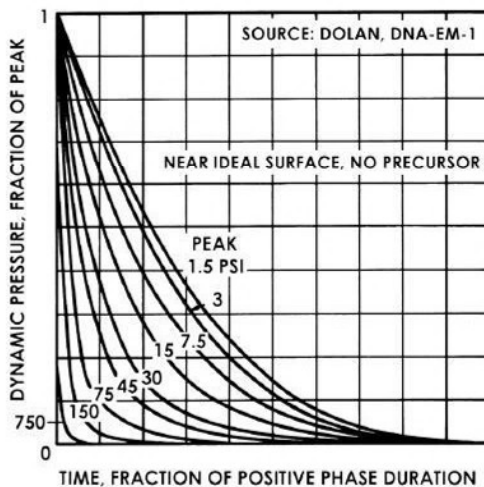



# Hiroshima

## THE NUMBER OF ATOMIC BOMBS EQUIVALENT TO THE LAST WAR AIR ATTACKS ON GREAT BRITAIN AND GERMANY

### Summary

During the last war, a total of 1,300,000 tons\* of bombs were dropped on Germany by the Strategic Air Forces. If there were no increase in aim accuracy, then to achieve the same total amount of material damage (to houses, industrial and transportation targets, etc.) would have required the use of over 300 atomic bombs together with some 500,000 tons of high explosive and incendiary bombs for targets too small to warrant the use of an atomic bomb. Increases in accuracy could cause a substantial reduction

Above: the Top Secret 1950 British Home Office Scientific Advisory Branch report, *The Number of Atomic Bombs Equivalent to the Last War Air Attacks on Great Britain and Germany*, was written by the World War II bomb damage Home Office civil defence experts including Frank H. Pavry, who went to Hiroshima and Nagasaki in 1945 on the British Mission to Japan. The 1950 pointed out the exaggerations of nuclear weapons effects in the popular media and calculated that the 1.3 megatons of small conventional weapons dropped on Germany were equivalent to over 300 nuclear weapons of 20 kt yield or  $300(20/1000)^{2/3} = 22$  nuclear weapons of 1 megaton yield, because of the wide distribution of targets. The non-linear scaling of nuclear weapons effects with energy yield causes the popular media to falsely dismiss civil defence by asserting that a single megaton nuclear weapon would duplicate German's bomb destruction in World War II.



Above: Glasstone's *Effects of Nuclear Weapons* points out Japanese buildings were constructed of timbers containing many pre-cut tenons, which weakened their strength. The typical wooden house at the top survived without fire damage 1.0 mile from ground zero, Hiroshima. The lower photo shows the construction method, using timbers with many tenons.



Above: three Japanese beer bottles fused together in the Hiroshima firestorm. Glass did not melt due to the thermal flash. The U. S. Strategic Bombing Survey, Medical Division, *The Effects of Atomic Bombs on Health and Medical Services in Hiroshima and Nagasaki*, March 1947, documents life continuing in the cities, on pages 81-83:

"Mitsubishi shipyards in Nagasaki were operating on a very reduced capacity. On 27 October [1945] they launched a 10,000-ton steel cargo ship, laid the keel for another one on 3 November, and had 5 other ships under way. ... Other shipyards were beginning or continuing operations and 6 steel ships were under way. Buildings were not available for other operations and labor was scarce. ... There was a critical shortage of skilled as well as unskilled labor, to a lesser extent owing to the removal of Koreans, Chinese, and prisoners of war. ... In Hiroshima ... Only 26 percent of the total industrial capacity of the city was destroyed ..."



Above: British Mission to Japan report, 1946, Fig. 18: "small earth-covered back yard shelter with crude wooden frame," within 100 yards of ground zero, Nagasaki. "There was a large number of such shelters ... only half were damaged at 300 yards ..."



Above: British Mission to Japan report, 1946, Fig. 17: "part below ground, earth-covered timber framed shelter," survived just 300 yards from ground zero in Hiroshima.

# Hiroshima

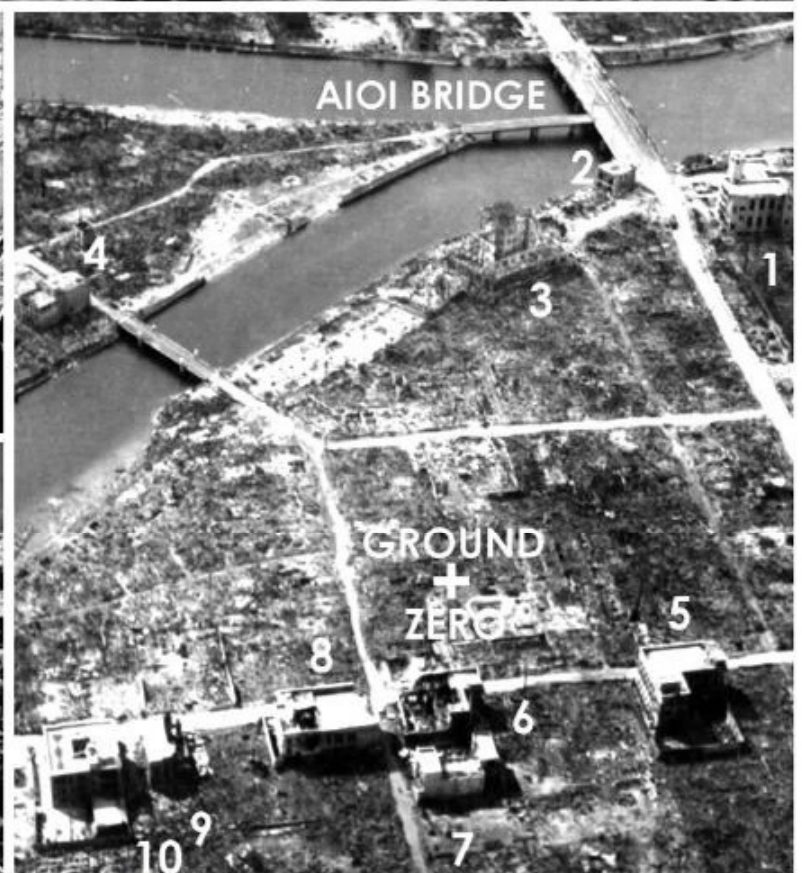
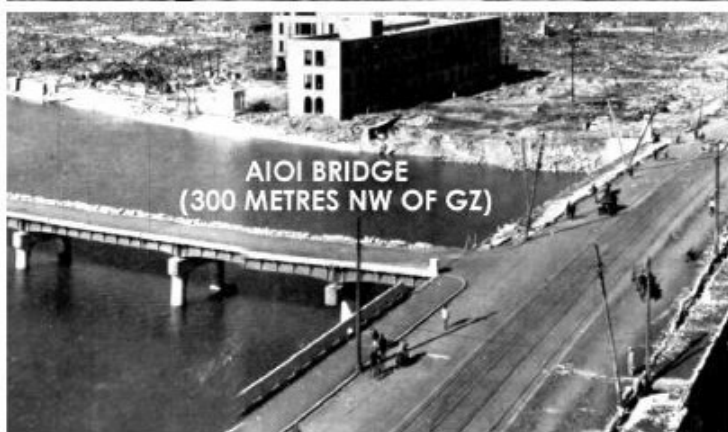
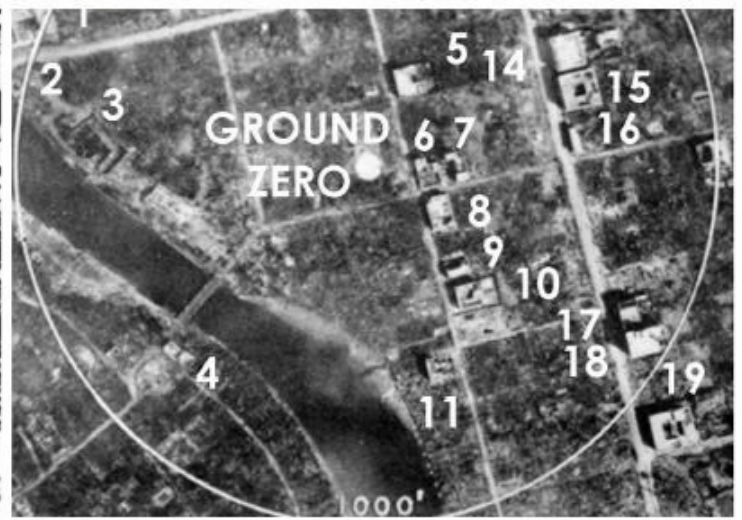

*Above: U. S. Strategic Bombing Survey photos of Hiroshima. Even the closest bridge, south west from ground zero, remained service-*

*able. The fire damage to wooden houses was not instant, but occurred 30 minutes to 3 hours afterwards (after most survivors had evacuated).*

# Hiroshima

## DIRECT EFFECTS OF 1 MT SURFACE BURST

LIGHT DAMAGE TO COMMERCIAL-TYPE BUILDINGS,  
MODERATE DAMAGE TO SMALL RESIDENCES

PERCENT OF PEOPLE  
DEAD HURT SAFE

MODERATE DAMAGE TO COMMERCIAL-TYPE BUILDINGS,  
SEVERE DAMAGE TO SMALL RESIDENCES

SEVERE DAMAGE TO  
COMMERCIAL-TYPE  
BUILDINGS

DESTRUCTION  
OF ALL EXCEPT SPECIALLY  
DESIGNED FACILITIES

MAX FIREBALL  
RADIUS 0.7 MILE  
OVER 12 PSI

CRATER DIAM. 0.24 MILE

1.7

3

5

7 MILES

50 40 10  
5-12 PSI

5 45 50  
2-5 PSI

25 75  
1-2 PSI

100  
0-1 PSI

POTENTIAL FIRE SPREAD

MANY FIRES INITIATED



**BANK OF JAPAN, HIROSHIMA (BUILDING 24)**



**GEIBI BANK COMPANY, HIROSHIMA (BUILDING 18)**

Left: the 1973 U. S. Department of Defense DCPA Attack Environment Manual provided this casualty-versus-peak overpressure analysis, associating the 5-12 psi peak overpressure zone with 50 mortality, without source references. It was used to for grossly deceptive exaggeration, ignoring civil defence effectiveness by the 1979 U. S. Office of Technology Assessment study, *The Effects of Nuclear War*. Deceptions were excluded from public scrutiny, debate and analysis by deliberately assigning reports secret and/or "limited distribution" (ostensibly to keep it from Moscow).

Left: 50% of 100 people survived inside the concrete Bank of Japan (building 24 in Hiroshima, in the U. S. Strategic Bombing Survey report) at a peak overpressure of 18 psi, just 390 metres from ground zero in Hiroshima, was well inside the "firestorm" area, and only 7.5 m from the nearest burning building. A second floor fire due to a firebrand blown through a broken window was extinguished by the survivors using water fire buckets at 1.5 hours after the nuclear explosion.

The unoccupied third floor later suffered a similar ignition which was discovered too late to extinguish and burned without spread to lower floors. (Source: DCPA Attack Environment Manual, Chapter 3, Panel 26, 1973. The U. S. Strategic Bombing Survey report shows that it had 12 inch thick reinforced concrete walls and 20 inches of sand on the roof.)

Left: the Geibi Bank building (building 18) survived 8 psi peak overpressure at 293 metres from ground zero in Hiroshima, again inside the "firestorm" area. It survived fire completely; firebrands blown in through first and third floor broken windows at 2.25 hours after the explosion ignited curtains and furniture but these fires were extinguished by survivors using water fire buckets. (U. S. Strategic Bombing Survey report shows that it had 10 inch thick reinforced con-

# Hiroshima

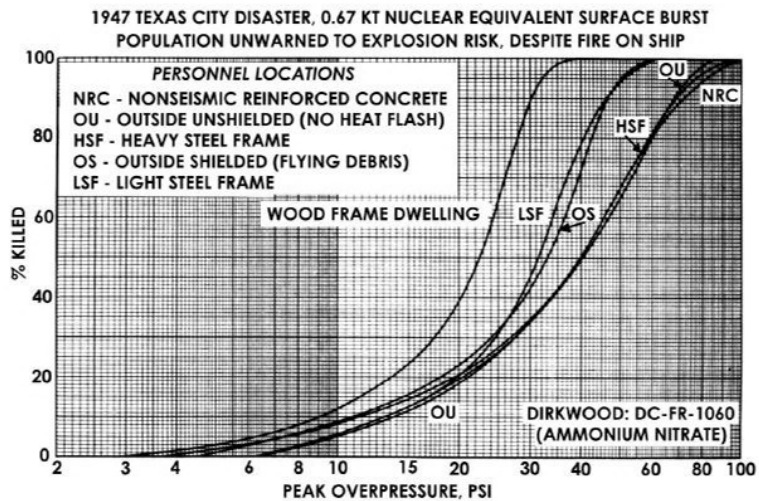

Above: casualty risks in the unwarned population from blast effects in typical kinds of American city building were firmly established after the 16 April 1947 Texas City Disaster. Because the ther-

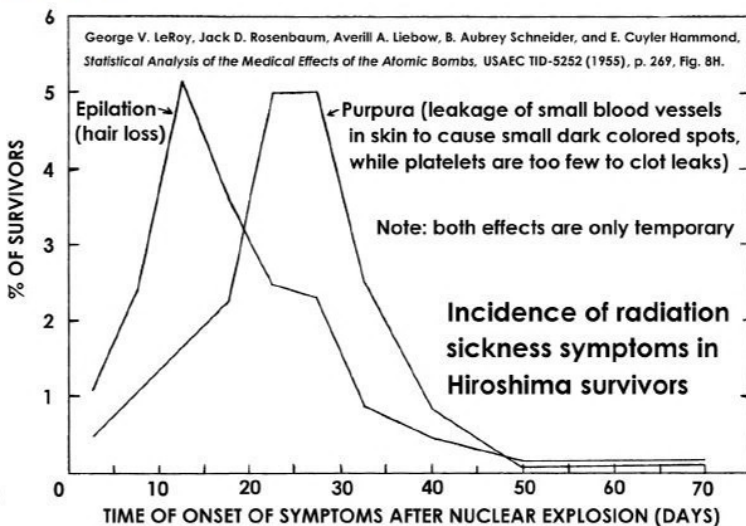

mal effects were trivial, people in the open were safer than those behind objects, due to the flying debris. Acute radiation syndrome affected fewer than 5% of the survivors of Hiroshima.

~~CONFIDENTIAL~~

DEPARTMENT OF THE ARMY TECHNICAL MANUAL  
 DEPARTMENT OF THE NAVY  
 DEPARTMENT OF THE AIR FORCE  
 MARINE CORPS PUBLICATIONS

TM 23-200  
 OPNAV INSTRUCTION 03400.1B  
 AFL 136-1  
 NAVMC 1104 REV

## FIGURE 5-2

Thermal effects:

Second degree bare skin burn . . .

~~CONFIDENTIAL~~

1 KT 100 KT 10 MT  
 (cal/cm<sup>2</sup>)

4 5.1 9.1

~~CONFIDENTIAL~~

Table 6-2. Critical Radiant Exposures for Burns Under Clothing

(Expressed in cal/cm<sup>2</sup> incident on outer surface of cloth)

Clothing	Burn	1 KT	100 KT	10 MT
Summer Uniform . . . . .	1°	8	11	14
(2 layers) . . . . .	2°	20	25	35
Winter Uniform . . . . .	1°	60	80	100
(4 layers) . . . . .	2°	70	90	120

Note. These values are sensitively dependent upon many variables which are not easily defined (see text), and are probably correct within a factor of two.

~~CONFIDENTIAL~~

Table 6-5. Dose Transmission Factors (Interior Dose/Exterior Dose)

Geometry	Gamma rays		Neutrons
	Initial	Residual	
Foxholes <sup>b</sup> . . . . .	0.05-0.10	0.02-0.10	0.3

<sup>b</sup> No line-of-sight radiation received.

DEPARTMENTS OF THE ARMY, THE NAVY  
 AND THE AIR FORCE

REVISED EDITION NOVEMBER 1957

~~CONFIDENTIAL~~

"A few secondary burns resulted from primary flaming of clothing but many people reported such instances in which they were able to beat the fires out without sustaining burns of the underlying

skin." - U. S. Strategic Bombing Survey, Medical Division, The Effects of Atomic Bombs on Health and Medical Services in Hiroshima and Nagasaki, March 1947, page 25.

Right: flash burns only occurred in an unobstructed radial line from the fireball, giving window area burns to chairs at 1 mile in Hiroshima, and fence "shadows" on scorched poles at 1.17 mile from ground zero in Nagasaki.

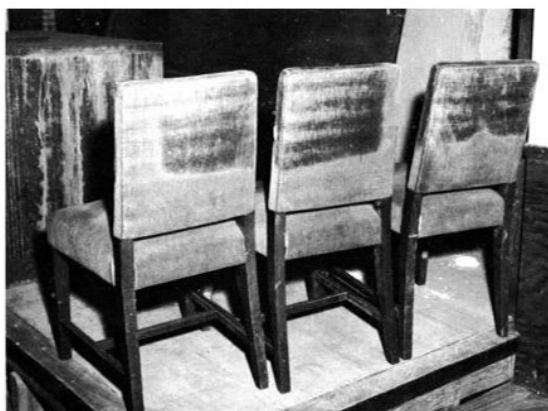

# Hiroshima

Right: very limited burn areas, under the dark patterns of a tight, single-layer Kimono dress, Hiroshima. Figs. 28 and 29 in Dirkwood Corp. report DC-FR-1054 show that the average unshielded lightly clothed person outdoors in Nagasaki had 2nd to 3rd degree (blistering to charring) burns to 20% of the body area at 1.86 km, killing 10%. At 1.37 km, the stronger flash heated clothing more, and 2nd to 3rd degree flash burns occurred to an average of 38% of body area for personnel unshielded outdoors, killing 50%. The U. S. Strategic Bombing Survey's Medical Division report, *The Effects of Atomic Bombs on Health and Medical Services in Hiroshima and Nagasaki* (March 1947) explains these facts about burns victims:

Pages 24-27: "The fires particularly in Hiroshima apparently built up more slowly than has been encountered in cities that were subjected to heavy incendiary raids. This gave persons more time to escape from the damaged or demolished buildings. ... A few secondary burns resulted from primary flaming of clothing but many people reported such instances in which they were able to beat the fires out without sustaining burns of the underlying skin. ... Generally speaking, the thicker the clothing was the more likely it was to give complete protection against flash burns. ... There were many instances where skin was burned beneath tightly fitted clothing, but was unburned beneath loosely fitted portions."

Page 43: "The Joint Commission studied a group of 580 workmen in Hiroshima who were marching across the Koi Bridge facing the bomb at a distance of 7,500 feet. All were burned with the exception of three at the rear who were protected by the eaves of a building." The British Mission to Japan report, *The Effects of the Atomic Bombs at Hiroshima and Nagasaki*, 1946, discusses that group of workmen on page 13, stating that 9 out of the 580 (1.55%) were killed by the serious flash burns at that distance (2.3 km).

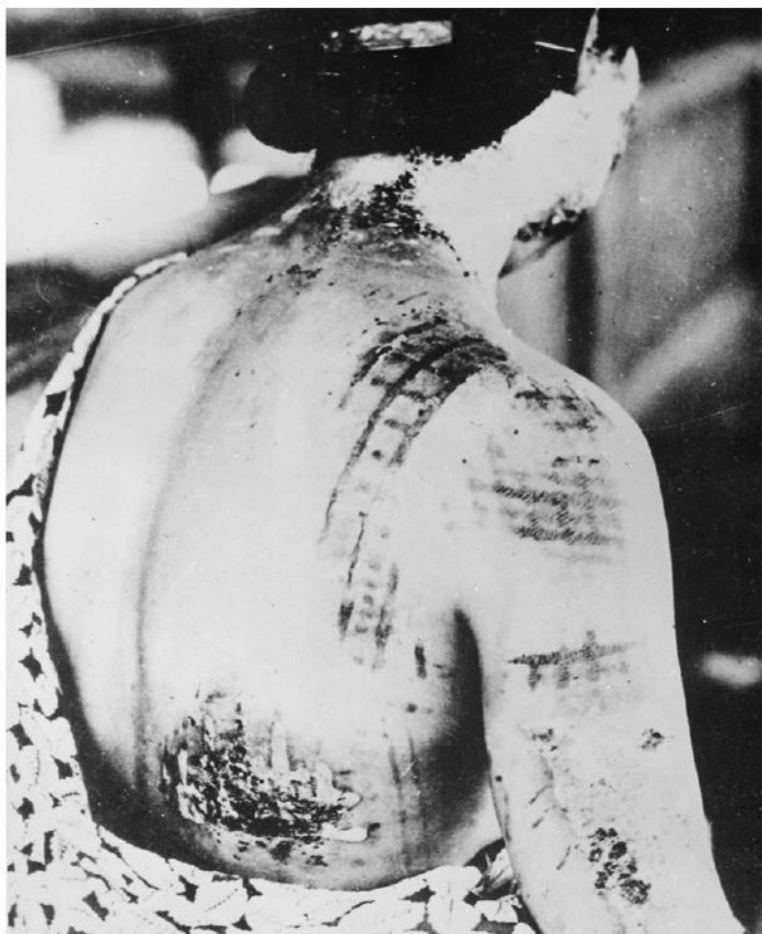

Above: U. S. Strategic Bombing Survey report photos of profile burns to a Hiroshima soldier, illustrating protection afforded against thermal flash burns by a cap and shirt at 1.98 km (1.23 miles) from ground zero. The unburned area below the neck

region was covered by clothing. Flash ignited clothing was beaten out and rolled out, unlike the contrived false "examples" of gasoline-soaked peacetime automobile accident burns, used by civil defence "critic" liars to supposedly "disprove" civil defense.

# Hiroshima

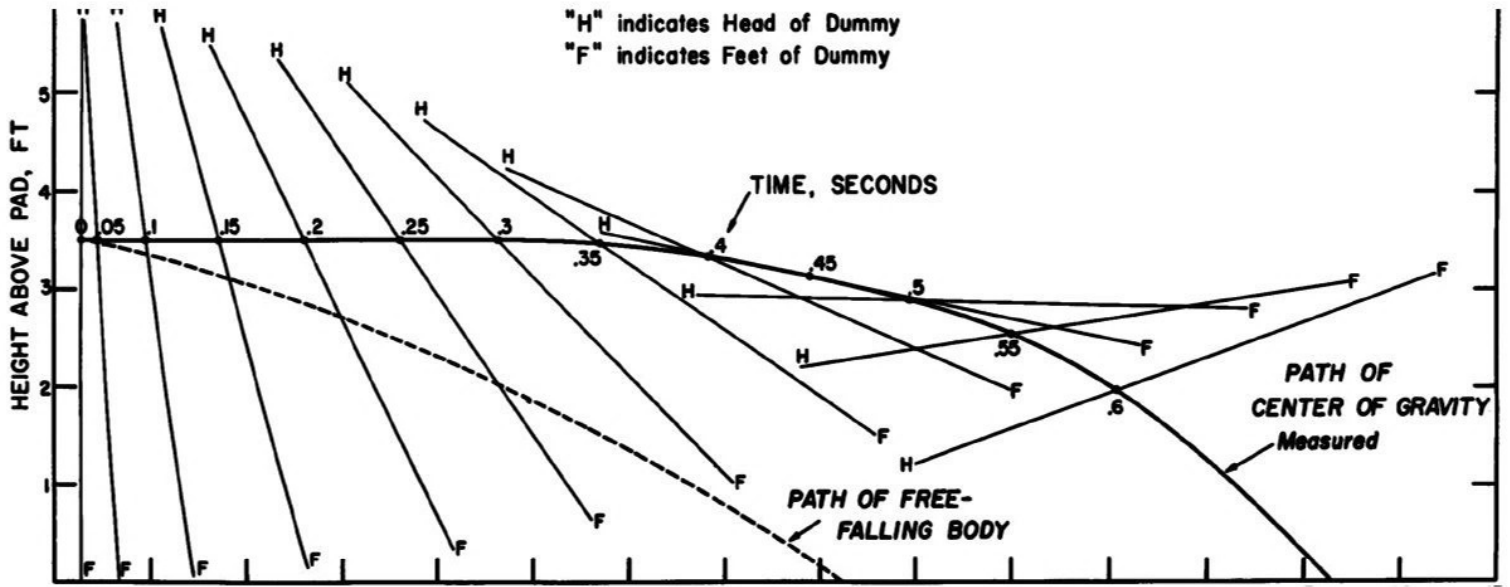

Above: in blast displacements the head impacts the ground vertically, it does not hit an obstruction at the peak horizontal velocity. The significance of this fact is that the overall effect is like a fall, albeit taking much longer than gravitation takes because of the hydrodynamic aerofoil lift (where the

back is sloping into the blast wind for the first 0.5 second, like an aerofoil). The extra half second of aerodynamic lift gives sufficient reaction time for people to use their arms to protect their heads from the vertical impact. This explains the high survival rate in the Mach stem region at Hiroshima.

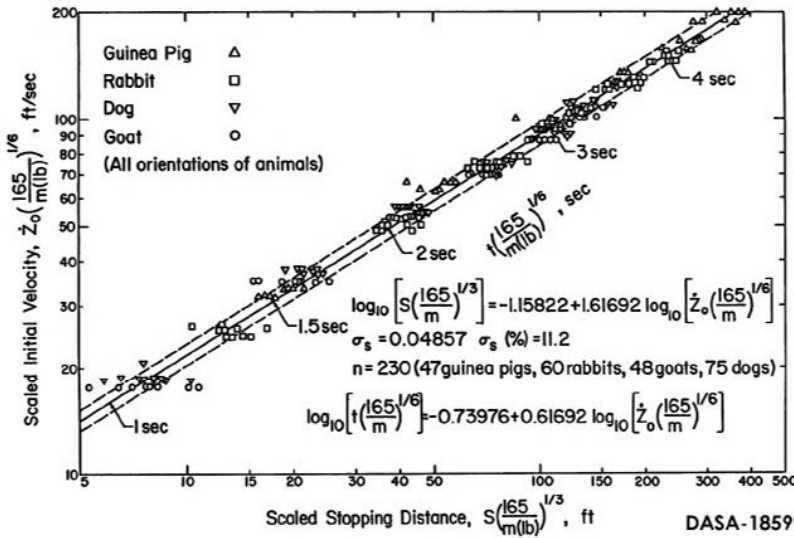

Above: the tumbling distances from blast displacement and the protective quality of clothing in preventing most serious injuries from flying glass fragments are established from experiments on animals. At the 400 kt 12 August 1953

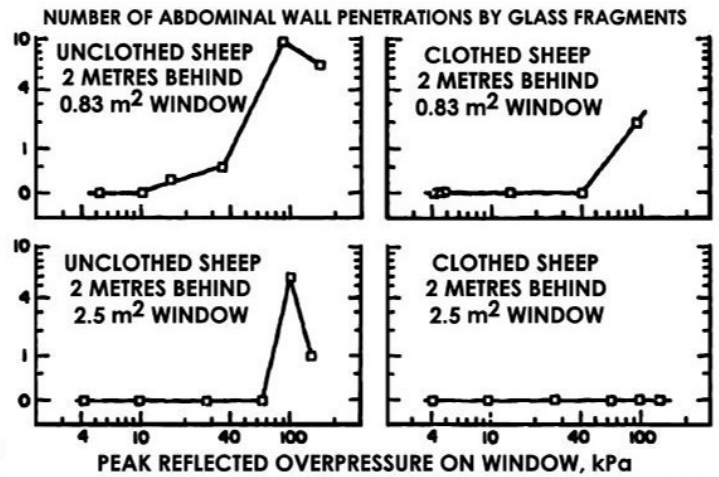

Source: DNA-5593T (ADA105824), 1980, Fig. 17. (1 PSI = 6.9 kPa.)

Russian nuclear test, 100% (all 6 animals) exposed outdoors on open ground to 8-10 cal/cm<sup>2</sup> survived all the effects, and only 11% (3 of 27) were killed outdoors at 15-26 cal/cm<sup>2</sup> (13 of the 27 had radiation sickness): DTRA-TR-07-38.

## Relation Between Overpressure and Missile Parameters

Max pressure psi	Type of missile	Velocity ft/sec		Mass, gms		Max missile density No/sq ft
		geometric mean	range	geometric mean	range	
1.9	Window glass	108	50-178	1.45	0.03-10	0.4
3.8	Window glass	168	60-310	0.58	0.01-10	159
5.0	Window glass	170	50-400	0.13	0.002-140	388

Above: Dr Clayton S. White's nuclear test data in his June 1959 testimony to U. S. Congressional hearings on *The Biological and Environmental Effects of Nuclear War*, page 331. Increasing the peak overpressure of the blast wave has a small effect on the mean speed of glass fragments, but causes a larger fall in their mean mass, because the blast breaks the window up into a very fine "powder" at higher overpressures. Smaller fragments have less momentum and less penetrating power at very high overpressures, and can be easily stopped by clothing or even the skin surface. White testified on page 330: "a 10 gram glass fragment, hav-

ing a velocity of 115 ft/sec has only a 1 percent probability of traversing the abdominal wall ... clothing will degrade the velocity..." Report DASA-1341 calculates a maximum distance for skin lacerations by 50 ft/sec, 10 gram flying glass fragments (acceleration coefficient 0.72 sq. ft/lb) of 7 miles from a 1 Mt surface burst. "At 25 degrees from the edge of a window pane, the density of glass fragments is approximately one-tenth the density of fragments measured directly behind the window." - M. K. Drake, et al., *Collateral Damage*. Science Applications, Inc., Defense Nuclear Agency report DNA 4734Z (ADA071371), 1978, page 5-86.

## The Effects of Atomic Weapons

PREPARED FOR AND IN COOPERATION WITH THE U. S. DEPARTMENT OF DEFENSE AND THE U. S. ATOMIC ENERGY COMMISSION

Under the direction of the  
LOS ALAMOS SCIENTIFIC LABORATORY  
LOS ALAMOS, NEW MEXICO



Revised September 1950

BOARD OF EDITORS

J. O. HIRSCHFELDER, *Chairman*      DAVID B. PARKER  
ARNOLD KRAMISH                      RALPH CARLISLE SMITH  
SAMUEL GLASSTONE, *Executive Editor*

For sale by the Superintendent of Documents, U. S. Government Printing Office  
Washington 25, D. C. - Price \$1.25 (paper bound)

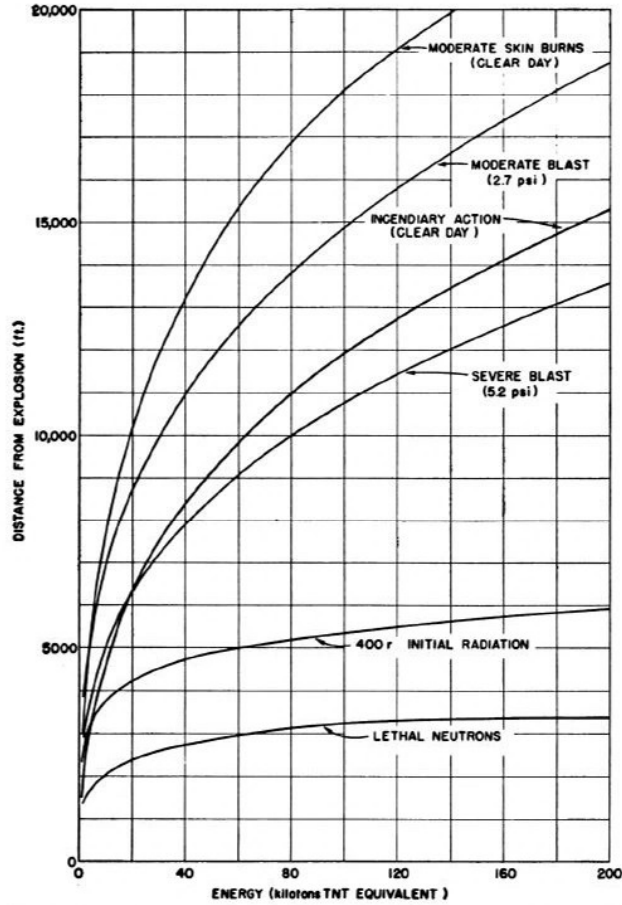

Figure 12.13. Distances from explosion at which various effects are produced as function of bomb energy.

Left: after the first Russian nuclear test of 1949, American government agencies published *The Effects of Atomic Weapons* in 1950. The book predicted the effects of air burst weapons (up to 200 kt). It failed to analyze the mechanism of the Hiroshima firestorm or the relationship between blast damage to buildings and casualties, giving no solid analysis of the effectiveness of civil defence.

## The Effects of Nuclear Weapons



SAMUEL GLASSTONE  
*Editor*

Prepared by the  
UNITED STATES DEPARTMENT OF DEFENSE  
Published by the  
UNITED STATES ATOMIC ENERGY COMMISSION  
June 1957

For sale by the Superintendent of Documents, U. S. Government Printing Office  
Washington 25, D. C. - Price \$2.00 (paper bound)

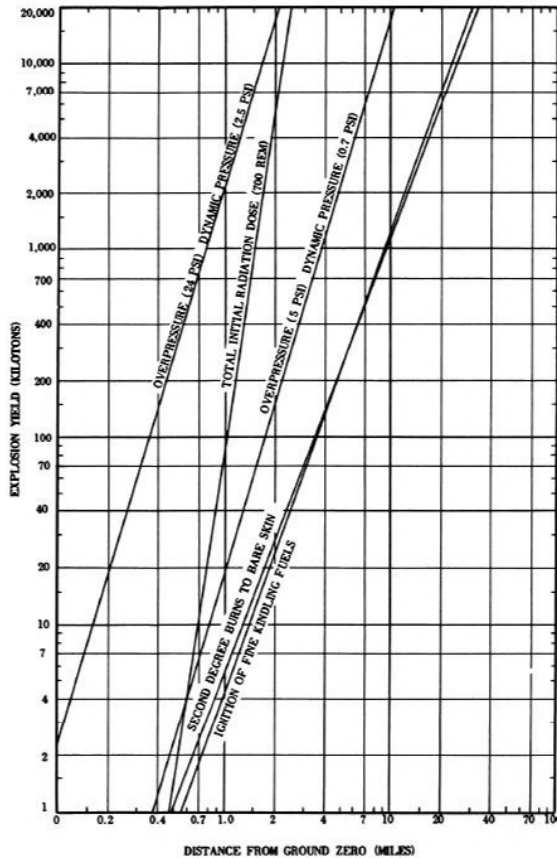

Figure 12.13. Limiting distances from ground zero at which various effects are produced, in an air burst.

Left: after the first Russian megaton yield air-dropped H-bomb test of 1955, American government agencies published *The Effects of Nuclear Weapons* in 1957. It severely exaggerated effects of blast and thermal flash burns and fires, predicting fires and 2nd degree bare skin burns at 30 miles from a 20 Mt air burst. The firestorm ignition analysis omitted vital eyewitness evidence from Hiroshima.

Above: the key failure of *The Effects of Atomic Weapons* and also *The Effects of Nuclear Weapons* to address widespread deceptions over thermal radiation burns casualties are due to the falsehood that building damage at Hiroshima correlated to casualties

(when in fact 100% survival was possible in the "severely destroyed" buildings, burned down 2-3 hours after the nuclear explosion by the firestorm, long after the survivors had evacuated). Their ranges for bare skin flash burns only apply to nudists.

# Hiroshima

U. S. Strategic Bombing Survey, Medical Division, *The Effects of Atomic Bombs on Health and Medical Services in Hiroshima and Nagasaki*, March 1947, page 25:

“A few secondary burns resulted from primary flaming of clothing but many people reported such instances in which they were able to beat the fires out without sustaining burns of the underlying skin.”

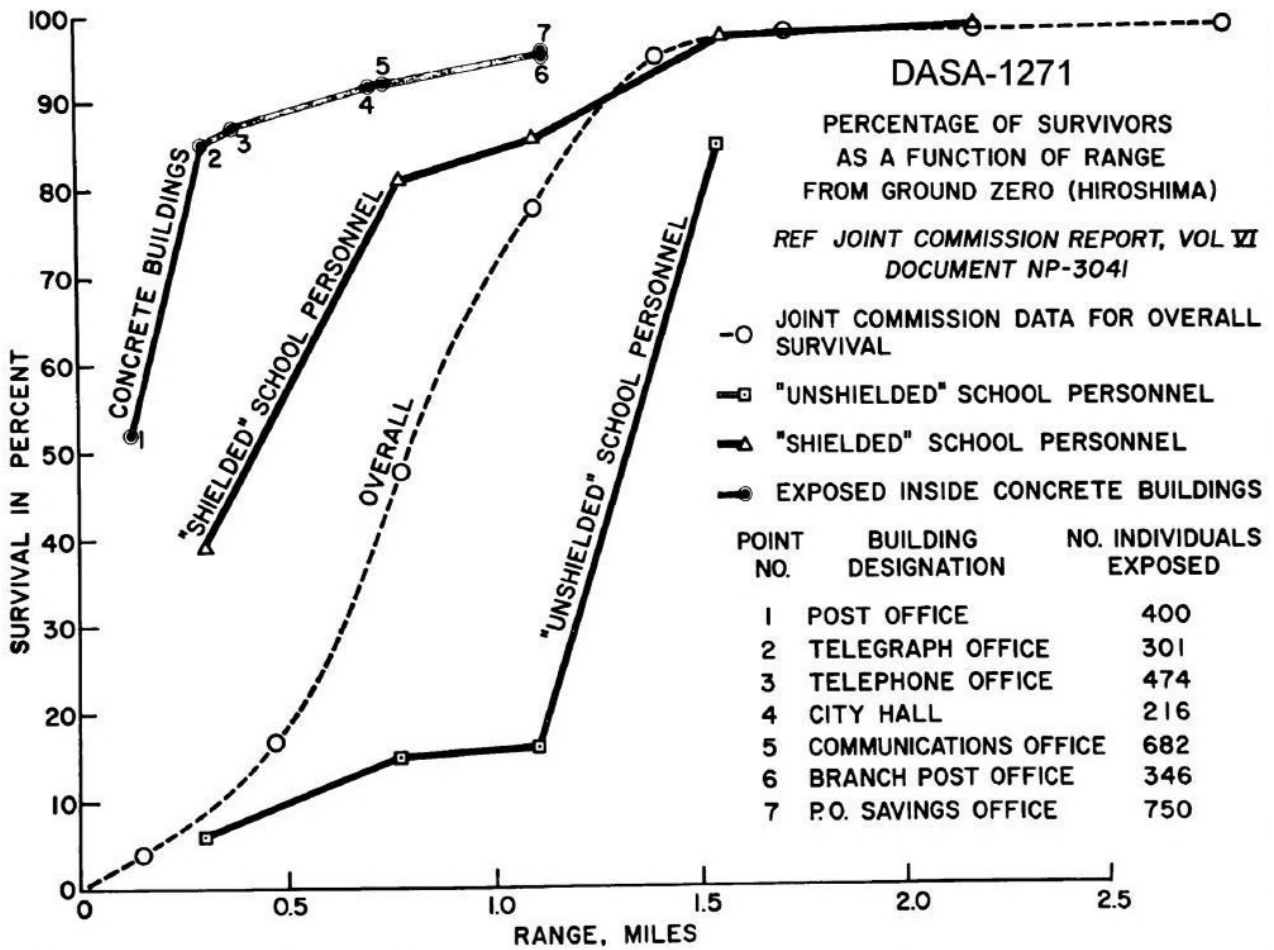

Dr Clayton S. White, M.D. (DASA-1271, 1961, pp. 32-36):

“The area of [destruction to wooden houses at Hiroshima, was] about 1.2 mile radius, a range at which 4-5 psi existed. At this range there was an overall survival of near 90 percent. ... one must not confuse the area of complete destruction of houses ... with ‘complete destruction’ of people. ...

“The gloomy habit of confusing the two concepts is, I am afraid, as prevalent as it is unrealistic and, indeed, untrue. ... Think of the differences in casualties which might have occurred in Hiroshima had the population just been mostly indoors.”

Samuel Glasstone and Philip J. Dolan, *The Effects of Nuclear Weapons*, U. S. Department of Defense, 3rd ed., 1977, paragraphs 12.14, 12.17, and 12.22, pages 545-7: “The high incidence of flash burns caused by thermal radiation among both fatalities and survivors in Japan was undoubtedly related to the light and scanty clothing being worn, because of

the warm summer weather ... If there had been an appreciable cloud cover or haze below the burst point, the thermal radiation would have been attenuated somewhat and the frequency of flash burns would have been much less. Had the weather been cold, fewer people would have been outdoors and they would have been wearing more extensive clothing. Both the number of people and individual skin areas exposed to thermal radiation would then have been greatly reduced, and there would have been fewer casualties from flash burns. ... The death rate in Japan was greatest among individuals who were in the open at the time of the explosions; it was less for persons in residential (wood-frame and plaster) structures and least of all for those in concrete buildings. These facts emphasize the influence of circumstances of exposure on the casualties produced by a nuclear weapon and indicate that shielding of some type can be an important factor in survival. ... Had they been forewarned and knowledgeable about areas of relative hazard and safety, there would probably have been fewer casualties even in structures that were badly damaged.”

Right: flash burns only occurred in an unobstructed radial line from the fireball, proved by window outline scorches to chairs 1.0 mile from ground zero in Hiroshima, and by the fence “shadows” on scorched poles at 1.17 mile in Nagasaki.





# Hiroshima

For a month before the Hiroshima and Nagasaki nuclear attacks on 6 and 9 of August 1945, weather aircraft were sent over the cities daily to "accustom the Japanese to seeing daytime flights of two or three bombers" (*The Tibbets Story*, the autobiography of 509th nuclear bombing group commander, Hiroshima pilot Colonel Paul Tibbets). B-29 weather aircraft preceded the nuclear B-29 bomber. In Hiroshima the air-raid warning sounded at 7 am, and the all-clear at 7:30 am, but the bomb was dropped at 8:09 am. Thousands cooked breakfasts on charcoal braziers in wooden homes. In Nagasaki, the air-raid sounded at 7:50 am but was cleared before the bomb fell.

The secret May 1947 U. S. Strategic Bombing Survey report 92 on Hiroshima reveals the facts on pages 4-6: "Six persons who had been in reinforced-concrete buildings within 3,200 feet [975 m] of air zero stated that black cotton black-out curtains were ignited by flash heat. ... A large proportion of over 1,000 persons questioned was, however, in agreement that a great majority of the original fires were started by debris falling on kitchen charcoal fires. ... There had been practically no rain in the city for about 3 weeks. ... There were no automatic sprinkler systems in building. ..."

The secret June 1947 U. S. Strategic Bombing Survey report 93 on Nagasaki states (v. 1, p. 10): "... the raid alarm was not given ... until 7 minutes after the atomic bomb ... less than 400 persons were in the tunnel shelters which had capacities totalling approximately 70,000."

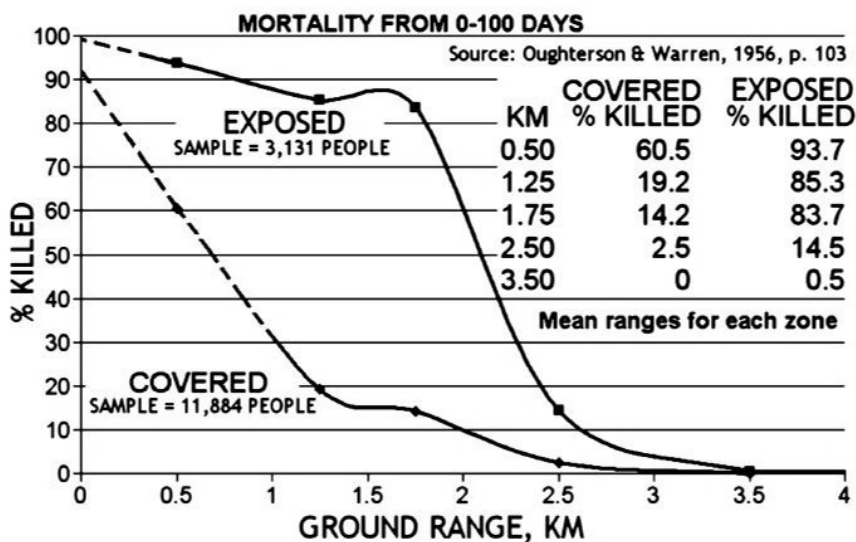

Above: data on survival for 15,015 Hiroshima work party children, from Dr Ashley Oughterson and Dr Shields Warren's book, *Medical Effects of the Atomic Bomb in Japan* (McGraw-Hill, New York, 1956, page 103). This graph shows that shadowing saved many lives. They noted the fire risk in Hiroshima on page 17: "Conditions in Hiroshima were ideal for a conflagration. Thousands of wooden dwellings and shops were crowded together along narrow streets and were filled with combustible material."

## MEDICAL EFFECTS OF ATOMIC BOMBS

The Report of the Joint Commission for the Investigation of the Effects of the Atomic Bomb in Japan; Volume VI

By  
 Ashley W. Oughterson    Henry L. Barnett  
 George V. LeRoy        Jack D. Rosenbaum  
 Averill A. Liebow       B. Aubrey Schneider  
 E. Cuyler Hammond

July 6, 1951  
 [TIS Issuance Date]

Army Institute of Pathology



UNITED STATES ATOMIC ENERGY COMMISSION  
 Technical Information Service, Oak Ridge, Tennessee

This document contains information affecting the national defense of the United States within the meaning of the Espionage Act, 50 U.S.C. 31 and 32, as amended. Its transmission or the revelation of its contents in any manner to an unauthorized person is prohibited by law.

**RESTRICTED**

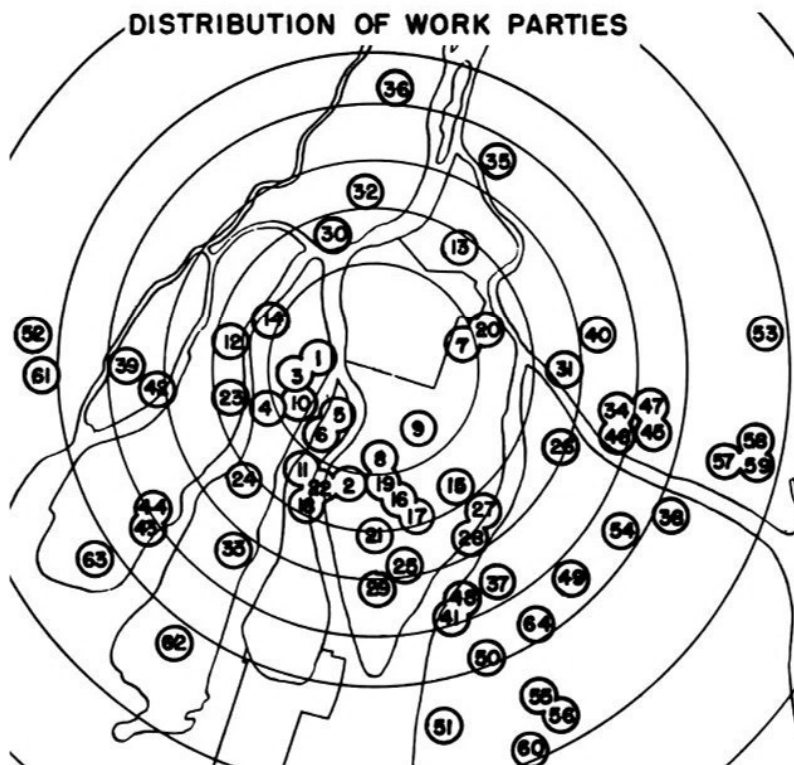

Above: 15,015 Hiroshima children were outdoors at known locations in patriotic work parties at 8:15am on 6 August 1945, clearing firebreak areas in overcrowded wooden housing, to try to prevent a firestorm occurring in anticipated incendiary air-raids. The data below is from Figures 9 and 10 in the report by Ashley W. Oughterson, et al., *Medical Effects of Atomic Bombs: The Report of the Joint Commission for the Investigation of the Effects of the Atomic Bomb in Japan*, Volume VI, U. S. Army Institute of Pathology, NP-3041, 1951.

At 0-1, 1-1.5, 1.5-2, and 2-3 km, mortality rates of 93.7, 85.3, 83.7, and 14.5% existed outdoors, but those shielded from the thermal flash had mortality rates of only 60.5, 19.2, 14.2, and 2.5% respectively (the firestorm developed between 30 minutes to 3 hours after burst, allowing time to escape it). Hence, shadowing in the four zones at 0-1, 1-1.5, 1.5-2, and 3-4 km gave mortality "protective factors" of 1.55, 4.44, 5.89 and 5.80, respectively. Since areas are proportional to the square of the radius, the higher protection fac-

tors predominate in overall casualty calculations, since the area of the 1-1.5 km "shell" zone exceeds that of the 0-1 km zone, and the area of the 1.5-2 km "shell" zone is much larger.

The areas covered between the inner and outer radii limits of each of the four zones (0-1, 1-1.5, 1.5-2, and 3-4 km) is  $\pi(a^2 - b^2)$ , where  $a$  and  $b$  are the outer and inner radii of the zone, respectively, giving 3.14, 3.93, 5.50 and 15.7 square kilometres. Thus, if the distribution of the pre-attack population without shielding is uniformly  $n$  persons per square kilometre, the number killed outdoors within 3 km is  $13.2n$  personnel, compared to just 3.83n personnel for those with shadow protection from the fireball's thermal radiation. So the overall shadow protective factor for mortality in randomly distributed people within 3 km of ground zero in Hiroshima was  $13.2n/(3.83n) = 3.44$ , reducing the unshielded death risk in Hiroshima to just 29%, for people shadowed from the fireball's thermal radiation flash by a tree, fence, clothing, building, vehicle, bridge, tunnel, or hill.

# Hiroshima

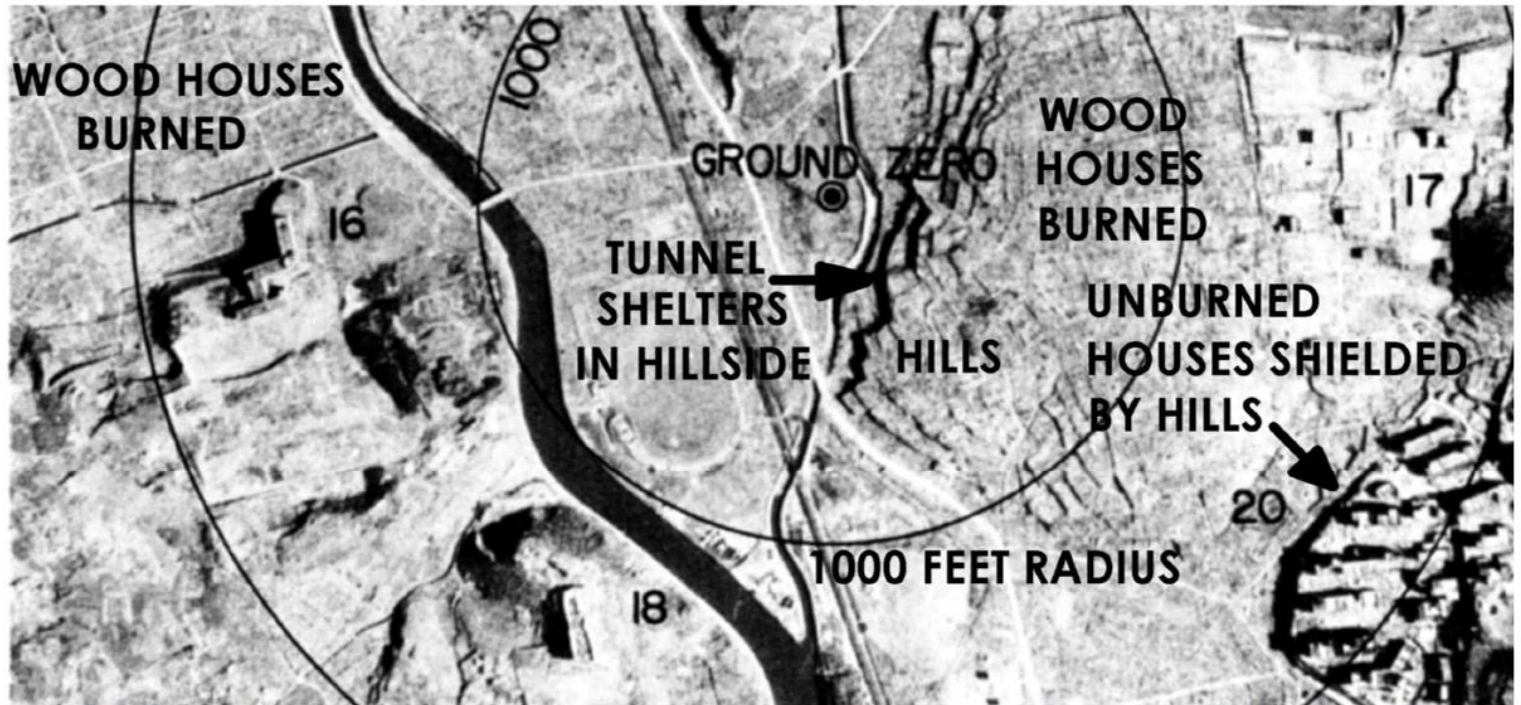

Above: Nagasaki before and after the 9 August 1945 nuclear attack. Buildings 16 and 18 are surviving but damaged Shiroyama and Chinzei schools, respectively, 500 metres west and south west of ground zero. In 1990, R. L. Stohler of Kaman Sciences Corp. used data on case histories of students on different floors inside these two Nagasaki schools to determine the 50% lethal dose (LD50) of initial nuclear radiation, including blast and thermal burn

synergisms: the LD50 is 412 cGy in air/295 cGy in the bone marrow for casualties with either nuclear radiation plus blast injury or only nuclear radiation, and 397 cGy in air/279 cGy in bone marrow for nuclear radiation in combination with thermal burns (report DNA-TR-87-173, ADA219691). This synergism is due to the later infection of wounds, which was worse in Hiroshima's hospitals than in Nagasaki's. Hills "shielded" the south east homes from firebrands.

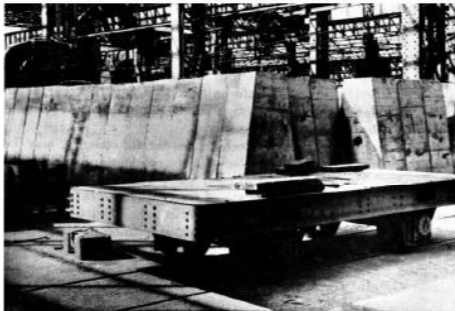

Above: Nagasaki's "blast walls," made of pre-cast concrete (left) and earth-filled wooden planks (right). The idea of a blast wall is to shield flying debris and hurricane-strength blast winds. The blast wall base is wider than the top, to prevent overturning for the blast load design specification. These simple blast walls protected machinery at 0.85 mile from ground zero, Nagasaki. The photographs of simple and effective protection were published in Figure 12.37 of the June 1957 edition of *The Effects of Nuclear Weapons*, but were not included in later editions.



Above: a typical multistorey steel-frame building surviving structurally intact at 0.85 mile from ground zero in Nagasaki. The surrounding wooden buildings collapsed and were burned by fires.

~~SECRET~~

LA-14066-H  
History

*Tracing the Origins of the W76:  
1966–Spring 1973 (U)*

*Betty L. Perkins*

*November 3, 2003*

**7. Yield: The Confetti Argument**

Agnew felt that the yield of the W68 was too low to be really effective. In addition, in terms of the overall total yield available from all the W68 warheads, the W68 design was very costly in terms of the amount of required special nuclear materials.

In an April 1972 TWX to Assistant Director for Safety and Liaison (Division of Military Application) Colonel Robert T. Duff, Agnew reported that he was worried about maintaining the U.S. nuclear deterrent. Agnew noted, "It occurs to me that as we go to lower and lower yields in our strategic missile warheads and the Soviet Union builds up a better and better civil defense position, the reality of this deterrent may become questionable.

(b)(3)

If the Soviet leadership believes this, then our strategic deterrent will have lost a good deal of its force. If our MIRV trend continues we'll be threatening to throw confetti at a potential aggressor. Confetti has high penetration and survivability but little deterrent power."<sup>281</sup>

In a letter dated October 10, 1972, to Giller, at that time Assistant General Manager for National Security, Agnew again noted several reasons why low yield warheads might not be the best solution for maximizing the deterrence capability of the stockpile. He reported that considering the number of required submarines and the low efficiency in their use of special nuclear material, the low-yield warheads were not very cost effective. Moreover, Agnew pointed out that for the Hiroshima device, the effects on Hiroshima in terms of loss of substantial buildings and the people in them "wasn't all that impressive." In terms of loss of life, the USSR had lost more than ten million people in WWII. Although the Soviets had an extensive civil-defense network in place, even if that did not work to reduce loss of civilian lives, the Soviets might not mind losing a few people. Agnew wrote, "Again, to me, to continue to increase warhead numbers at the cost of a decrease in yield per warhead could eventually lead to no deterrence in the minds of those we hope to deter." Agnew stated, "I feel very strongly that we should endeavor to convince the DoD that what they should have on the next round is a mix of yields.

<sup>281</sup>H. M. Agnew, University of California, Los Alamos Scientific Laboratory, Los Alamos, N.M. to BY3/Colonel Robert T. Duff, USAF, Assistant Director for Safety and Liaison, Division of Military Application USAEC, Wash., D.C. (SRD) (April 14, 1972), pp. 1–2, B11, Drawer 56, Folder 1 of 4.

(b)(3)

LA-14066-H

~~SECRET~~

VI-69



#### HOW MAN COMES BACK TO HIROSHIMA: *New Homes Arise in the Bomb Devastation*

*The first atom bomb to be dropped in anger fell on Hiroshima on August 6 last year. The death and destruction caused was greater than any that had happened in any other single moment of time. But already a new Hiroshima is rising. Colonies of wooden hutment houses are being built to house the homeless.*

## AFTER THE ATOM BOMB: AN ASTONISHING REBIRTH

**The atom bomb lives up to all expectations in its immediate destructiveness. The scientists' predictions of the after effects of its explosion, however, have been dismally—or perhaps hopefully—wide of the mark.**

**WHAT** would happen to Hiroshima and Nagasaki on the days when the atom bombs dropped was not a matter for speculation. The diabolical thing had been tried out; the range and completeness of its destructive powers were known. Most people's hatred of the idea of indiscriminate slaughter was assuaged by a hope that in a few seconds of time the new form of warfare would end the war and prevent months of prolonged struggle. Hiroshima and Nagasaki suffered wounds which were mortal to the Japanese Empire. That much was expected, that much achieved.

On the long-term effects of the radioactivity released, the scientists had a field day of speculation. With various degrees of certainty they predicted that all life—animal and vegetable—would be impossible for many years on the scorched and acrid desert left

by the explosions. Their predictions have proved false. They underestimated the resistance of both Man and Nature. The houses rise again in the two bombed cities. The earth, which was expected to become sterile, now blossoms and bears fruit. Does this mean that we had been unduly terrified by the prospects of atomic warfare? Not at all. The killing and the maiming of the population of whole cities will be as extensive as ever the scientists calculated. Some kinds of civilisation may perish if ever the bomb is used again in full-scale war. But results so far seen show very definitely that the world will survive. Odd men will crawl out of spectacular immunity to build again, as best they know how, and food and flowers will defy all science's efforts at destruction. The atom bomb is not the Last Weapon after all. That may or may not be a source of consolation.



#### HOW NATURE COMES BACK TO NAGASAKI

*In the shadow of wreckage caused by the second atom bomb, crops thrive in the hutment gardens in denial of the scientists' predictions that growth would be impossible for many years.*